



**Fisheries New Zealand**

Tini a Tangaroa

# Blue cod potting surveys: standards and specifications: Version 2

New Zealand Fisheries Assessment Report 2019/21

M.P. Beentjes

ISSN 1179-5352 (online)

ISBN 978-0-9951269-5-4 (online)

July 2019



Requests for further copies should be directed to:

Publications Logistics Officer  
Ministry for Primary Industries  
PO Box 2526  
WELLINGTON 6140

Email: [brand@mpi.govt.nz](mailto:brand@mpi.govt.nz)

Telephone: 0800 00 83 33

Facsimile: 04-894 0300

This publication is also available on the Ministry for Primary Industries websites at:

<http://www.mpi.govt.nz/news-and-resources/publications>

<http://fs.fish.govt.nz> go to Document library/Research reports

**© Crown Copyright – Fisheries New Zealand**

## Table of Contents

|  |    |
|--|----|
| EXECUTIVE SUMMARY .....                              | 1  |
| 1. INTRODUCTION.....                                 | 2  |
| 1.1 Version 2.....                                   | 2  |
| 1.2 Background to blue cod surveys.....              | 2  |
| 1.3 The requirement for a potting survey manual..... | 3  |
| 1.4 Blue cod ageing.....                             | 3  |
| 2. TERMINOLOGY.....                                  | 3  |
| 3. BLUE COD POTTING SURVEY DESIGN .....              | 6  |
| 3.1 Timing of the surveys.....                       | 6  |
| 3.2 Gear specifications .....                        | 6  |
| 3.3 Survey type.....                                 | 7  |
| 3.3.1 Fixed-site surveys.....                        | 7  |
| 3.3.2 Random-site surveys .....                      | 9  |
| 3.3.3 Site order and soak time .....                 | 10 |
| 3.3.4 Allocation of phase 1 and 2 sites .....        | 11 |
| 3.3.5 Baiting pots.....                              | 11 |
| 4. SAMPLING AND DATA RECORDING AT SEA.....           | 11 |
| 5. OTOLITH PREPARATION AND READING.....              | 13 |
| 6. DATA ERROR-CHECKING AND STORAGE.....              | 14 |
| 6.1 Error checking and loading .....                 | 14 |
| 6.2 Data archiving .....                             | 14 |
| 7. DATA ANALYSIS .....                               | 15 |
| 7.1 Catch rates .....                                | 15 |
| 7.2 Length-weight parameters.....                    | 15 |
| 7.3 Scaled length and age frequencies.....           | 16 |
| 7.4 Total mortality (Z).....                         | 17 |
| 7.5 Spawner per recruit analyses (SPR) .....         | 18 |
| 7.6 Report format .....                              | 19 |
| 8. ACKNOWLEDGMENTS.....                              | 19 |
| 9. REFERENCES.....                                   | 20 |
| 10. TABLES AND FIGURES .....                         | 23 |
| 11. APPENDICES.....                                  | 44 |



## **EXECUTIVE SUMMARY**

**Beentjes, M.P. (2019). Blue cod potting surveys: standards and specifications: Version 2**

*New Zealand Fisheries Assessment Report 2019/21. 62 p.*

This document is a revised version of the blue cod potting survey manual and replaces Version 1, which was published in 2011 (i.e., *New Zealand Fisheries Assessment Report 2011/29*). The manual provides all information required to design and carry out blue cod potting surveys, as well as the required analyses, data summaries, and report format. Terms commonly used on blue cod potting surveys have been defined and updated in a terminology section. Blue cod potting survey at-sea data recording forms and associated instructions have been updated, as have instructions on how to error check and archive data. Ageing methodology in this report has been updated based on the age determination protocol published by the Ministry for Primary Industries in 2017.

## 1. INTRODUCTION

### 1.1 Version 2

This report presents version 2 of the blue cod potting survey manual which documents the current standards and specifications for survey design, procedures, reporting forms, gear specifications, survey strata, biological at-sea sampling, post-survey analytical methods, ageing protocols, report outputs, and data archiving. It is written principally for research providers, giving detailed instructions for designing, conducting and analysing each of the nine South Island surveys, including those in the marine reserves. It also defines standard terminology that will ensure consistency in data interpretation and report outputs. Version 2 replaces Version 1 which was published in 2011 (Beentjes & Francis 2011).

### 1.2 Background to blue cod surveys

South Island blue cod populations supporting important recreational fisheries are monitored using potting surveys contracted by Fisheries New Zealand. These are carried out predominantly in areas where blue cod recreational fishing is common, but in some areas, such as Foveaux Strait, there is substantial overlap between the commercial and recreational fishing grounds. There are currently nine blue cod survey time-series located in key recreational fisheries around the South Island, repeated every three to four years (Table 1, Figure 1).

The Fisheries New Zealand potting surveys monitor local relative abundance, and fish size, age, and sex structure of geographically separate blue cod populations. They provide a measure of the response of populations to changes in fishing pressure and management initiatives such as area closures or changes to the daily bag limit or the minimum legal size. One method to investigate the status of blue cod stocks is to estimate fishing mortality, the associated spawner-per-recruit ratio (SPR) and the Maximum Sustainable Yield (MSY) related proxy. Further, the population sex ratios are of major significance for blue cod, which are protogynous hermaphrodites with some (but not all) females changing into males as they grow (Beentjes & Carbines 2005). The largest fish in the populations are invariably males and skewed sex ratios towards a higher proportion of males is often observed for heavily fished blue cod populations. This is thought to result from the removal of the inhibitory effect of large males, and a consequent higher rate (and possibly earlier onset) of sex change by females (Beentjes & Carbines 2005). Recent experimental studies have indicated that in the protogynous hermaphroditic tuskfish (*Choerodon schoenleinii*), this process may be density dependent, with the degree of male to female tactile stimulation regulating the extent of sex change from females to males (Sato et al. 2018). Sex change is more likely to occur at low levels of behavioural interaction between a dominant male and a female. Tuskfish is a wrasse belonging to the family Labridae and is found in the Indo-Pacific region, whereas blue cod is endemic to New Zealand and belongs to the family Penguipedidae.

Fisheries New Zealand has surveyed Ulva Island (Te Wharawhara) Marine Reserve during the Paterson Inlet surveys three times as of the end of 2018 and will continue to include this reserve in future surveys. Fisheries New Zealand has begun to routinely include those marine reserves, found within close proximity to survey areas, into the potting survey designs, because the data from marine reserves provides additional power to evaluate the impacts of fishing in the open areas. Marine reserves recently added to existing surveys include: Long Island (Kokomohua) Marine Reserve, as part of the 2017 Marlborough Sounds survey; Hikurangi Marine Reserve, as part of the 2017 Kaikoura survey; and the Akaroa and Pohatu Marine Reserves, as part of Bank Peninsula surveys.

In addition to Fisheries New Zealand potting surveys, the Department of Conservation have carried out three independent blue cod potting surveys within and outside Pohatu Marine reserve, the most recent of which also included Akaroa Marine Reserve carried out in collaboration with NIWA in 2017 (Table 2). The purpose of the Department of Conservation surveys is, firstly, to determine if there are any changes to

blue cod abundance and population structure within the marine reserves, following their establishment, and secondly, to monitor these populations.

### 1.3 The requirement for a potting survey manual

The development and publication of Version 1 of the blue cod potting survey manual in 2011 (Beentjes & Francis 2011) provided the first standards and specifications for survey design, analysis, and database protocols, ensuring consistency within and between surveys. Before the publication of the potting manual, survey design and at-sea methods were often influenced by the logistical and pragmatic aspects of carrying out potting surveys in the highly variable South Island coastal environments. Data analyses were also often implemented on a largely *ad hoc* basis. Some of the 2011 potting manual survey design specifications originated from a Fisheries New Zealand two-day workshop in Wellington in April 2009, convened to review New Zealand blue cod potting surveys methods. This workshop covered many aspects of the surveys, including survey design, at-sea sampling procedures, ways to ensure consistency among time series, ageing methodology, and data analysis, as well as standard outputs of abundance, sex ratios, and age/length composition. An overseas expert review panel attended the meeting and subsequently produced a report summarising the findings of the meeting and outlining potential improvements (Stephenson et al. 2009). A key recommendation was that blue cod would be more appropriately surveyed using a random-site design, where the site to be surveyed is any location (single latitude and longitude) generated randomly from within a stratum (Beentjes & Francis 2011). Until this time, all surveys had used a fixed-site design in which predetermined locations (fixed sites) were randomly drawn from a limited pool of sites chosen on the basis of information from fishers that these were ‘hot spots’ at which blue cod were abundant (Beentjes & Francis 2011). Apart from the Foveaux Strait series in which random sites have been the only site type used, surveys in other areas have now all been transitioned to a fully random survey design with the interim sampling of both fixed and random sites (i.e., dual surveys) allowing comparison of catch rates, length and age composition, and sex ratios between the survey designs. Regardless of the fixed-random-site survey overlap, random-site surveys constitute a new time series.

### 1.4 Blue cod ageing

A blue cod ageing workshop was held in July 2014 to determine the most appropriate methods to prepare and read sagittal otoliths and interpret age from them. The recommendations from this workshop were incorporated in the first blue cod age determination protocol (ADP) published in 2017 (Walsh 2017). Only blue cod ages estimated in compliance with the ADP methodology are considered to be accurate and valid. Hence, many of the earlier published length/ages, age compositions and resulting mortality and spawner-per-recruit estimates are considered to be invalid. For some surveys, (Foveaux Strait 2010 and 2014; Marlborough Sounds 2013) (Beentjes et al. 2018, Beentjes et al. 2019) otoliths were re-read to be compliant with the ADP. Readers are referred to the most recent published reports for each survey for information on the status of ageing as it relates to each time series (Table 1).

## 2. TERMINOLOGY

Fishery Assessment Reports for surveys carried out before Version 1 of this manual was available may have used terminology inconsistent with this manual. The following terminology and conventions should be used in all future blue cod potting surveys and reports. Data from blue cod potting surveys are stored in the Fisheries New Zealand *trawl* database, and some of the terms used in this report were chosen to be consistent with the *trawl* table attributes and the *trawl* database documentation (Mackay 2015).

Fisheries New Zealand *trawl* database tables are written in italics, and table attributes in bold.

| Term              | Description  |
|-------------------|--|
| <b>trip_code</b>  | <p>The survey trip code is a 7-character code unique to the <i>trawl</i> database that identifies the blue cod survey. Three characters for the vessel code (typically the first 3 characters of the vessel name), plus two digits for the year and another two digits for the trip number, e.g., ika1801 is a valid <b>trip_code</b> for the first survey in 2018 using the research vessel R.V. <i>Ikatere</i> (Table A2.1). The <b>trip_code</b> should be approved by the Fisheries New Zealand Research Data Manager before the start of the survey.</p>  |
| <b>stratum</b>    | <p>A geographical area (polygon) defined by a series of latitudes and longitude coordinates (WGS84 projection). Boundaries of the stratum may be determined by depth contours, coastline, or other geographical features. A survey will generally have multiple strata. For the Dusky Sound and Marlborough Sound surveys, where pots are set along a length of coastline, strata are also defined by a polygon. For example, the coastline and waters of inner Queen Charlotte Sound is a stratum.</p> <p>A <b>stratum</b> within a survey, by convention will have a unique code of no more than two numeric characters (usually 1, 2, 3, ... 14). Letters should not be used in the <b>stratum</b> term except for the existing Dusky Sound surveys or when distinguishing between subdivided strata, for example 8 and 8a. Marine reserve stratum names can have up to three characters with any alpha-numeric combination. There is provision in the <i>trawl</i> database in the attribute <b>descriptn</b> of the table <i>t_stratum</i> table to provide a description of the stratum, e.g., stratum 1 for Marlborough Sounds has the description 'IQCS, inner Queen Charlotte Sound'. The current strata for each survey are defined in Table A2.2. Stratum boundaries for each survey are stored in <i>t_stratum_defn</i>.</p> |
| <b>station_no</b> | <p>The station number uniquely identifies each station within a survey. The station number is formed by concatenating the set-number with the pot-number. Thus, pot 4 in set 23 would be <b>station_no</b> 234 (Table 3). This convention is important in enabling users of the <i>trawl</i> database to determine whether two pots are from the same set. Note that the set numbers for potting surveys are not recorded as standalone attributes in the <i>trawl</i> database.</p>   |
| <b>stn_code</b>   | <p>A station code is an alphanumeric label of no more than 4 characters unique within a survey. There are two types of station codes; those from fixed sites and those from random sites.</p> <p>Fixed site station codes identify each fixed site and also specify which <b>stratum</b> it falls within. The <b>stn_code</b> is the concatenation of <b>stratum</b> and an alpha label (A–Z) that is unique within that <b>stratum</b>. Thus, sites within stratum 2 could be labelled 2A, 2B, and sites in stratum 3 could be labelled 3A, 3B, etc (Table 3).</p> <p>Random site station codes identify each random site and also specify which <b>stratum</b> it falls within. The <b>stn_code</b> is the concatenation of <b>stratum</b> and an alpha label (A–Z) that is unique within that <b>stratum</b>, but in addition, should be prefixed with 'R'. Thus, sites within stratum 2 could be labelled R2A, R2B, and sites in stratum 3 could be labelled R3A, R3B, etc.</p>  |
| site              | <p>A geographical location near to which sampling may take place during a survey, i.e., around which pots are set. A site may be either a fixed-site or a random-site. A site may be specified as a latitude and longitude, or a section of coastline (for the latter, the latitude and longitude at the centre of the section is used). The site location and details are stored in <i>t_site</i>.</p>  |



|               |  |
|---------------|--|
| set           | A group of pots (usually 6 or 9) deployed in the vicinity of a selected site on a specific survey. The configuration of pots in the water is defined by the type of pot placement.   |
| station       | The position (latitude and longitude) at which a single pot (or other gear such as line or ADCP) is deployed at a site during a survey, i.e., it is unique for the survey. To avoid confusion, it is important that the term station is not used to refer to a set or site (as defined above). The station location is stored in table <i>t_station</i> (attributes <b>lat_s</b> , <b>lat_f</b> , <b>long_s</b> , <b>long_f</b> ).   |
| fixed-site    | A predetermined location available to be used repeatedly on subsequent surveys. For each survey, fixed sites are randomly drawn from the limited pool of such sites. Fixed sites are sometimes referred to as an index site or fisher-defined site. All possible fixed-site locations for a given survey are stored in the <i>trawl</i> database in table <i>t_site</i> and are assigned to the trip code for the first trip ( <b>initial_trip</b> ) to define the site.   |
| random-site   | A random site is any location (single latitude and longitude) generated randomly within a stratum. This can be within a stratum polygon, or the centre of a length of coastline.   |
| set number    | The set number is assigned to each consecutive set within a survey. Thus, any set within a survey is uniquely defined by a <b>trip_code</b> and set number. Note that the set number is not recorded in the <i>trawl</i> database in isolation but is entered as part of attribute <b>station_no</b> in table <i>t_station</i> . Set numbers are assigned sequentially in the order fished.  |
| pot number    | Pots are numbered sequentially (1 to 6 or 1 to 9) in the order they are placed during a set. Pots are not uniquely identified as they are constructed from a pot plan and are all identical.   |
| Pot placement | <p>Pot placement is the method used to determine where to place the pot on the seafloor. There are two types of pot placement:</p> <p>Directed – used only for fixed sites where the position of each pot is directed by the skipper using local knowledge and the vessel echo-sounder to locate a suitable area of reef/cobble or biogenic habitat. Directed pot placement depends on the perceived suitability of the habitat.</p> <p>Systematic – used only for random sites where the position of each pot is arranged 1) systematically around the site in a hexagon pattern, or 2) either side of the site position for a length of coastline. Systematic pot placement is independent of the perceived suitability of the habitat.</p> <p>Pot placement type is entered in the second character of attribute <b>categories</b> of <i>t_station</i> in the <i>trawl</i> database. The convention is to enter ‘D’ for directed pot placement, and ‘S’ for systematic pot placement. Pot placement type should also be documented in the survey trip comments.</p> |

Fisheries New Zealand *trawl* database table documentation can be found at: <https://marlin.niwa.co.nz/databases>

### 3. BLUE COD POTTING SURVEY DESIGN

This manual is an adjunct to the surveys; for more details specific to each survey the reader is referred to the documented reports (Table 1). The manual should be carried aboard the vessel during the survey as a reference document.

#### 3.1 Timing of the surveys

The blue cod potting surveys are generally (but not always) timed to coincide with spawning, but in some surveys little spawning activity has been recorded. Of more importance is the ability to carry out the survey within a limited and unbroken time period, and accordingly most surveys are in late spring or summer-autumn when weather tends to be more settled. Most importantly, surveys within a time series should always be carried out at the same time of the year.

#### 3.2 Gear specifications

##### Vessels

Research providers undertaking fixed-site surveys attempted to use the same vessel and skipper to maintain consistency across the time series (Table 3; Table A2.1) – because pot placement for fixed-site surveys was directed by the skipper according to bottom features. It is not important which vessel or skipper is used to conduct random-site surveys, as long as the skipper has experience potting for blue cod and the vessel is equipped to pot for blue cod. Vessels should be small enough to safely manoeuvre close to the coastline and rocky outcrops, but be large enough to carry six or nine pots, at least three people, and be equipped with hydraulic systems suitable for setting and lifting blue cod pots and the Acoustic Doppler Current Profiler (ADCP) unit. Vessels should also have GPS capability (the datum of this GPS system to be included in the Trip comments, e.g. WGS 1984), a colour depth sounder and seaplot (or similar) software. Vessels used to date have included the NIWA inshore research vessel *Ikatere* and commercial charter vessels that fish for blue cod. Vessels should have a current New Zealand Certificate of Survey (valid for the area of the survey and number of persons on board), and the skipper should hold a current New Zealand Certificate of Competency. Health and Safety inductions by the skipper to the sea-going science-staff are required, as is a briefing to the skipper and crew relating to any safety issues when conducting the survey work. For example, the procedures for setting and hauling pots and the ADCP, dealing with the catch and the use of any chemicals such as those used to sterilise gear or preserve samples.

##### Pots

All pots used in the blue cod surveys should be built to strict specifications to avoid any selectivity changes associated with potential differences in pot construction. Pots used for the Marlborough Sounds surveys should be built using Pot Plan 1 specifications (Figures 2 and 3). All other surveys (including new surveys) should use pots built to Pot Plan 2 specifications (Figures 4 and 5).

##### Acoustic Doppler Current Profiler (ADCP)

It is routine to deploy an ADCP on the seafloor during each set to record bottom water temperature, and current speed and direction in 1 m bins above the transducer. There are generally up to 30 bins of data recorded, depending on depth. The ADCP unit is deployed over the site position immediately before the first pot of a set is placed and recovered after the last pot of the set is lifted. The ADCP units are designed to run continuously and data are downloaded at the end of the survey.

ADCP specifications from a recent survey are: High-performance, 3-axis (3D) acoustic Doppler Current Profiler (ADCP, RDI Instruments, 600 kHz).

### 3.3 Survey type

Two types of survey design have been used in the blue cod potting survey time series – fixed-site surveys, and random-site surveys (see Section 2 and Table 1). All future surveys, except in Dusky Sound<sup>1</sup>, are planned to be of solely random-site design, so the methodology that applies to fixed-site surveys is provided here largely for historical context, and for interpretation of past surveys that used this design. For any future survey the design and pot placement method must be presented to the Fisheries New Zealand Southern Inshore Working Group for approval.

Surveys areas are divided into strata, with the aim of partitioning regions that may have different catch rates or fish distributions. Stratum size and boundaries for the nine blue cod surveys were drawn based on fishing intensity, depth contours, headlands, habitat, harbours, bays and arms of sounds, etc. Stratum boundaries should not be altered between surveys without consulting Fisheries New Zealand. The reader is referred to the documented survey reports for stratum details (Table 1).

Stratum areas that have been used to scale catch and length frequencies are as follows:

|                              |  |
|------------------------------|--|
| Marlborough Sds and Dusky Sd | stratum area is equal to the coastline length (km) for both fixed-site and random-site surveys.  |
| Banks Peninsula inshore      | stratum area was equal to the coastline length (km) before 2012 for all fixed-site surveys. In 2012 it was taken as the area of polygons (km <sup>2</sup> ) out to 500 m from shore for both fixed-site and random site surveys.<br>In 2016, strata area was equal to the coastline length (km) for the fixed-site survey, and as the area of polygons (km <sup>2</sup> ) out to 500 m from shore for the random-site survey.  |
| Banks Peninsula offshore     | stratum area was equal to three times the length of the longest side of the two rectangular polygons (km) before 2012 for all fixed site surveys. In 2012, for both fixed-site and random-site surveys, strata area was equivalent to the area of polygons (km <sup>2</sup> ), redrawn in 2012 after a sonar survey of the biogenic reefs.<br>In 2016, strata area was equal to three times the length of the longest side of the two rectangular polygons (km) for the fixed-site survey, and equivalent to the area of polygons (km <sup>2</sup> ), redrawn in 2012 after a sonar survey of the biogenic reefs for the random-site survey. |
| All other surveys            | stratum area is equal to the area of polygons (km <sup>2</sup> ).  |

If stratum areas are changed, then all previous surveys must be re-analysed using the new strata to ensure that catch and length frequencies are scaled in a relative manner.

#### 3.3.1 Fixed-site surveys

Fixed-site surveys have a pool of pre-determined locations (sites). For each survey in the time series, a subset of sites is randomly selected from the larger pool of fixed sites. Thus, each fixed site has some chance of being included or not included in a survey.

---

<sup>1</sup> The SINSWG (2016/26) recommended that at least one more dual survey (fixed-site and random-site) was required for Dusky Sound.

## Site selection

Sites are randomly selected from the pool of fixed sites before the start of the survey. These already exist for the current surveys in table *t\_site* and should not be added to or altered. For most surveys there are at least 10 possible fixed sites per stratum. These fixed sites were identified by recreational or commercial fishers, from fishing magazines, or were located within optimal blue cod habitat where catches were known to be good, with the constraint that they were at least 1.5 km apart. An exception is if the fixed site is within an embayment, in which case the distance across the bay to another fixed site, may be no less than 0.5 km.

## Pot placement

Fixed-site pot placement is always ‘directed’ and depends on the perceived suitability of the habitat. The position of each pot is determined by the skipper using local knowledge and the vessel echo sounder to locate a suitable area of reef/cobble or biogenic habitat. Pots are set either 1) in a cluster around the site location, or 2) along a specified length of shoreline extending away from the site position in both directions.

The specific pot placement methods used for each survey area are:

### All surveys (except those below)

At each fixed site, six pots (pot plan 2) are set in a cluster around the site location, no further than 0.5 km from the site position, but separated by at least 100 m (Figures 6a). The position of each pot is determined by the skipper, within suitable habitat.

### Dusky Sound

At each fixed site, six pots (pot plan 2) are set along the shoreline extending away from the site position in both directions but separated by at least 100 m (Figure 6b). The length of the coastline within which the pots are set is 1.5 km. The position of each pot is determined by the skipper within suitable habitat which is generally confined to a narrow band along the shore. For sites outside of Dusky Sound away from the shore, the pot placement method described above for ‘all surveys’ should be used, i.e., set in a cluster around the site location.

### Marlborough Sounds

At each fixed site, nine pots (pot plan 1) are set along the shoreline extending away from the site position in both directions but separated by at least 100 m (Figure 6b). The length of the coastline within which the pots are set is 1.0 km. The position of each pot is determined by the skipper within suitable habitat which is generally confined to a narrow band along the shore. For sites outside of Marlborough Sounds away from the shore where setting along the coastline is not practical, the pot placement method described above for ‘all surveys’ should be used, i.e., set in a cluster around the site location.

### Inshore Banks Peninsula

At each fixed site, six pots (pot plan 2) are set along the shoreline extending away from the site position in both directions but separated by at least 100 m (Figure 6b). The length of the coastline within which the pots are set is 1.0 km. The position of each pot is determined by the skipper within the band of rocky habitat which can extend as far out as 500 m from shore. Pot placement further offshore may take the shape of a cluster if the rocky habitat dictates.

In dual fixed and random-site surveys, if sites fall within 1 km of each other, the random-site takes precedence and a new fixed site is selected from the pool.

### 3.3.2 Random-site surveys

Random-site surveys are those in which all sites are generated randomly either 1) within a defined stratum polygon, or 2) from the centre of a randomly selected segment of coastline.

#### Site selection

**Defined stratum polygon** – Sufficient random sites to cover both first and second phase stations should be generated within each stratum polygon with the constraint that sites are at least 800 m apart. From this list, the allocated number of random sites per stratum to be surveyed is selected in the order that they were generated.

**Segment of coastline** – The coastline of the survey area is divided into 1.01 km segments (excluding coastline sections less than 1 km such as rocks or small islands) and a latitude and longitude at the centre of each segment is assigned (examples in Figures 7 and 8). From this list the allocated number of random sites per stratum to be surveyed is randomly selected. The same sites can be used on subsequent surveys without the need to regenerate segments because all possible random sites for the area are included in this list.

#### Pot placement

Random site pot placement is ‘systematic’ and independent of the perceived suitability of the habitat. The position of each pot is arranged either 1) around the site in a hexagonal pattern, or 2) along a specified length of shoreline extending away from the site position in both directions.

The specific pot placement methods used for each area are:

##### **All surveys (except those below)**

At each random site, six pots (pot plan 2) are set. The first pot is placed 200 m to the north of the site location and remaining pots are placed in a hexagonal pattern around the site, 200 m from the site position (Figure 9a). If the site is too close to the shore to place pots in the standard hexagon shape and dimensions, either move the site away from the shore until pots can be accommodated, or space pots out in a systematic manner around the site. Minimum depth of pots is 5 m, except Paterson Inlet where it is 3 m.

##### **Dusky Sound**

The Dusky Sound coastline is divided into 1.01 km segments (excluding coastline sections less than 1 km such as rocks or small islands) and a latitude and longitude at the centre of each segment is assigned, giving 364 potential random sites (see Figure 7). From this list the allocated number of random sites per stratum to be surveyed is randomly selected.

Six pots (pot plan 2) are set along the shoreline every 100 m, starting from a point 250 m from the random site position, each in a randomly selected depth over the extent of the habitat as it extends out perpendicular from the shore (Figure 9b). For much of Dusky Sound, blue cod habitat is over narrow rocky ledges running along the shoreline that drop-off steeply to depths exceeding 100 m. Acceptable depths for pot placement are between 5 and 80 m unless a drop-off is encountered below 80 m in which case the pot is placed at a random depth between 5 m and the drop-off depth.

##### **Marlborough Sounds**

The Marlborough Sounds coastline is divided into 1.01 km segments (excluding coastline sections less than 1 km such as rocks or small islands) and a latitude and longitude at the centre of each segment is assigned, giving 1195 potential random sites (see Figure 8). From this list the allocated number of random sites per stratum to be surveyed is randomly selected.

Nine pots (pot plan 1) are set along the shoreline every 100 m, starting from a point 450 m from the random site position, each in a randomly selected depth over the extent of the habitat as it extends out perpendicular from the shore, but not less than 2 m depth (Figure 9b).

### **Inshore Banks Peninsula**

The site selection and pot placement methods used in the first two inshore Banks Peninsula random-site surveys in 2012 and 2016 (Beentjes & Fenwick 2017, Carbines & Haist 2017b) were different and are described below.

**2012 random site survey** – the coastline was divided into 1 km segments and a latitude and longitude at the centre of each segment was assigned (Carbines & Haist 2017b). From this list the allocated number of random sites per stratum to be surveyed was randomly selected. The six pots (pot plan 2) were set in a row adjacent to the coastline, separated by approximately 100 m, on the outer edge of the narrow band of rocky habitat. Pot placement was limited to within 500 m from shore, a distance equal to the maximum offshore pot distance from previous fixed site surveys and assumed to represent the extent of the habitat band off the coast.

**2016 random site survey** – the 2016 random-site survey design was the same as that described above for ‘All surveys’ selecting from random-sites generated within a stratum polygon, and pots were placed in a hexagon shape around the site (Beentjes & Fenwick 2017). The stratum polygons were the same as those used in 2012 (between the coast and the seaward boundary 500 m from shore).

**Future random-site surveys** – Site selection as for 2012 survey, but pots are placed at a randomly selected distance perpendicular to the shore out to 500 m from shore, or for embayments the distance to half way across the bay, but not in less than 5 m depth.

Research providers should consult with Fisheries New Zealand to determine the appropriate design before commencing an inshore Banks Peninsula random site survey.

### **Marine Reserve surveys**

Marine reserve surveys (Long Island, Pohatu, Akaroa, Hikurangi, Ulva Island) should use random-site survey designs and adhere to the pot placement methods used for the wider survey unless advised otherwise by Fisheries New Zealand (described above in Section 3.3.2). Marine reserve surveys require an authorisation from DOC specifying the conditions including that no fish are to be killed. Data collected will include catch weight, individual fish length and weight (with weight optional).

Specific survey details of site selection and pot placement should be described in the table *t\_trip\_comm* in the *trawl* database.

### **3.3.3 Site order and soak time**

In general, strata should be sampled in the same order as previous surveys, particularly Marlborough Sounds where the survey can extend to over 30 days. The order that strata and sites are surveyed will depend to some extent on the prevailing weather conditions, as exposed offshore strata (e.g., offshore Banks Peninsula) can be sampled only during relatively calm conditions. After each site is completed, the next closest site in the stratum should be sampled, i.e., do not attempt to standardise for time of day or tides. Pots should be left to fish (soak) for a minimum of 1 hour during daylight hours. Soak time should be as close to 1 hour as possible and should not exceed 1 h 15 min. Pots should be retrieved in the same order that they were set.

### 3.3.4 Allocation of phase 1 and 2 sites

Both fixed and random site surveys use a two-phase stratified random site design, as is commonly used for trawl surveys (Francis 1984). The optimal number and allocation of sites among strata should be determined from simulations using catch rate data from previous surveys. Simulations should be constrained to have a minimum of three sites per stratum and achieve a CV (coefficient of variation) of no higher than 15%.

For existing surveys, the proportion of phase 2 sites should be kept approximately constant between surveys to maintain a consistent bias in catch rate estimates among surveys. Research providers should consult the appropriate survey documents for this proportion. For new surveys, the number of phase 2 sites should be approximately 10% of all sites surveyed. All the allocated sites (phase 1 and 2) must be used (if time and resources permit) even if the overall target CV has been achieved earlier.

The determination of which strata should have additional sites in phase 2 of the survey is based on the mean catch rate of all blue cod per stratum (kg per pot) and optimised using the “mean squared” method of Francis (1984). In this way, phase 2 sites are assigned iteratively to the stratum in which the expected gain is greatest, where expected gain is given by:

$$\text{expected gain}_i = \text{area}_i^2 \text{mean}_i^2 / (n_i(n_i + 1))$$

where for the  $i$ th stratum  $\text{mean}_i$  is the mean catch rate of blue cod per pot,  $\text{area}_i$  is the fishable stratum area, and  $n_i$  is the number of sets in phase 1. In the iterative application of this equation,  $n_i$  is incremented by 1 each time a phase 2 set is allocated to stratum  $i$ .

The stratum and survey *area* is measured in square kilometres (km<sup>2</sup>) for all surveys except Marlborough Sounds and Dusky Sound where it is the length of the coastline in kilometres. Inshore and offshore Banks Peninsula fixed-site surveys use length of coastline (offshore uses a proxy for coastline length); and random-site surveys use the area of stratum polygons.

### 3.3.5 Baiting pots

Pots should be baited with 700 g of paua (*Haliotis iris*) viscera purchased from commercial fish processors. The weight of bait used should be kept constant. The viscera (thawed not frozen) are placed inside a plastic container termed a ‘sniffer pottle’ with slits on the side and small holes on the lid to allow the scent plume of the paua viscera to escape easily into the pot and surrounding area (see Figures 2–5). Pots are re-baited every time the pot is set (not topped up), and any remaining bait should be discarded. There is a field on the set record to enter the percentage of the bait remaining when the pot is lifted.

## 4. SAMPLING AND DATA RECORDING AT SEA

Six form-templates for recording data at-sea have been designed specifically for the blue cod potting surveys (Appendix 1). These forms have been used in blue cod potting surveys since 2010, but were revised in 2018, with the exception of form 5. Form 6 has no earlier version.

1. Blue Cod Potting Survey Trip Record (2018)
2. Blue Cod Potting Survey Set Record (2018)
3. Blue Cod Potting Survey Catch Record (2018)
4. Blue Cod Potting Survey Length and Biological Form – Blue Cod (2018)
5. <sup>2</sup>Blue Cod Potting Survey Length and Biological Form – Other Species (2010)

---

<sup>2</sup> This form is not used on routine blue cod surveys.

6. Blue Cod Potting Survey Otolith Sample Tick Sheet (2018). (*Separate form for males and females*)

The suffix date on the form name should be changed to reflect the latest version of the form. Detailed instructions for filling out all fields in the forms are provided in Appendix 2. These instructions should be carried with the forms to ensure that all fields are completed in a standardised format and in accordance with *trawl* database requirements (e.g., using the valid units for sea condition, sea colour, wind speed, etc.). While the forms are applicable to other methods (Appendix 2), such as lining, the descriptions below will describe their use for potting only. Waterproof versions of these forms are required at sea.

### **Form 1. Trip Record**

The trip record contains general information about the trip such as start and finish dates, survey and strata areas, reference to the specifications of the gear used, and personnel (Appendix 2). Only one trip record form is required for the trip and this can be completed at the end of the trip.

### **Form 2. Set Record**

Complete the set record header at the beginning of the set, and the middle section after each pot is placed. When each pot is placed, record the sequential pot number (currently 1–6, or 1–9), start and finish time, latitude and longitude from vessel GPS, and pot depth (in metres) (Appendix 2). At the bottom of the set record, enter environmental data which should be collected after all pots have been set and are soaking. After lifting each pot, using the vessel hydraulic pot lifter, record gear performance and percent of the bait remaining in the snifter pottle.

### **Form 3. Catch Record**

After a soak time of at least 1 hour (but not more than 1 hour 15 min), pots are lifted aboard in the same order they were set using the vessel hydraulic pot hauler, emptied, and the contents sorted by species. Using motion compensating scales ( $\pm 10$  g) (Marel or Seaway scales have been used so far) record the total weight per pot of each species on the catch record form; blue cod at the top of the form and other species in the bottom section (Appendix 2). Also, enter the number of individuals of each species per pot, the percent sampled and tick the boxes if measurements were made of length, biologicals (individual fish weight or gonad staging), or if otoliths were taken. For blue cod and other species, the weigh method will almost always be 1 and the percent sampled 100%, unless a very large catch is made that needs to be sub-sampled. For species other than blue cod, unless requested by Fisheries New Zealand, only the total weight and number of individuals is recorded for each pot, i.e., no length, biologicals or otoliths. For hagfish it is acceptable to record only numbers as this species is difficult to weigh without the hagfish covering scales and buckets with mucus. Comments can be made at the bottom of the form on any aspect relating to the set.

### **Form 4. Length and Biological Form – Blue Cod**

Use this form only for recoding information on individual blue cod. For all blue cod, measure total length (TL) to the nearest millimetre, fish weight to the nearest 10 g, and record sex and gonad maturity (Appendix 2). Sex and maturity are determined by dissection and macroscopic examination of the gonads. A gonad staging photographic guide is shown in Figure 10. From a representative size range, remove both sagittal otoliths from up to five fish of each sex per one-centimetre size class over the available length range, spread across all strata. Fish number starts at one for each set (not pot) and continues sequentially, resetting to one for the next set. Rinse and clean dissected otoliths with water, place dry in 0.65 ml plastic Eppendorf tubules and then in paper otoliths packets labelled with trip code, set number, stn\_code, station number (= set-pot number), species, fish number, date, length, sex, and collector. Store and handle envelopes with care as blue cod otoliths are fragile and easily broken.

### **Form 5. Length and Biological Form – Other Species**

In the event that biological information is required for species other than blue cod, use this form. Most of the fields are the same as on form 4 except that there is provision to enter species name and species



code (Appendix 2). Data collection should be tailored to the species sampled (e.g., appropriate length measurement method and gonad staging method).

### **Form 6. Otolith Sample Tick Sheet**

This form allows an inventory to be kept of the numbers of otoliths collected by sex, length and stratum to inform the sampler on the progress of the collection across these variables. Use a separate form for males and females.

### **Data backup at sea**

To guard against loss of the hard-copy paper forms before data are loaded in the *trawl* database, backups are required to be made at the end of every day's sampling. This can be in the form of either photos or scanned copies of the forms which should then be sent electronically that day to a secure site remote from the location of sampling.

## **5. OTOLITH PREPARATION AND READING**

Preparation and reading of otoliths should follow the methods documented in the blue cod age determination protocol (ADP) (Walsh 2017).

1. Blue cod otolith thin-section preparations are made as follows: using a cold light source on low power to light the otolith from behind, each otolith is individually marked on its distal face with a dot in the centrum. Five otoliths (from five different fish) are then embedded in an epoxy resin mould and cured at 50 °C. Thin sections are taken along the otolith dorso-ventral axis through the centrum of all five otoliths, using a Struers Accutom-50 digital sectioning machine, with a section thickness of approximately 350 µm. Resulting thin section wafers are cleaned and embedded on microscope slides using epoxy resin and covered with a coverslip. Finally, these slides are oven cured at 50°C.
2. Otolith sections are read against a black background using reflected light under a compound microscope at a magnification of 40–100 times. Under reflected light opaque zones appear light and translucent zones dark. Translucent zones are counted (ageing of blue cod otolith thin sections prior to 2015 counted opaque zones to estimate age).
3. Two readers will read all otoliths without reference to fish length.
4. Readers should have first read the blue cod reference collection and attained a minimum standard before beginning to read the survey otoliths (see Walsh 2017).
5. When interpreting blue cod zone counts, both ventral and dorsal sides of the otolith are read, mainly from the core toward the proximal surface close to the sulcus.
6. The forced margin method is used: 'Wide' (a moderate to wide translucent zone present on the margin), October–February; 'Line' (an opaque zone in the process of being laid down or fully formed on the margin), March–April; 'Narrow' (a narrow to moderate translucent zone present on the margin), May–September.
7. Where between-reader counts differ, the readers will recheck the count and confer until agreement has been reached, unless the section is a grade 5 (unreadable) or damaged (removed from the collection).
8. Between-reader ageing precision should be assessed by the application of the methods and graphical techniques documented in Campana et al. (1995) and Campana (2001); between reader agreement, including IAPE (Index of average percent error) and coefficient of variation (CV). See graphical outputs in Beentjes et al. (2019).

## 6. DATA ERROR-CHECKING AND STORAGE

### 6.1 Error checking and loading

Research providers will ensure that survey data are thoroughly error checked before submitting to the Fisheries New Zealand Research Data Manager (NIWA, Greta Point, Wellington) in a spreadsheet that mirrors the attributes within the tables in *trawl* and *age* databases.

All catch data collected from the potting survey are loaded into the FNZ *trawl* research database, and age reading results into the *age* research database. Catch data should be provided within one month, and age data within three months after the survey is completed. Instructions for users of these data and researchers submitting data for these databases can be found at: <https://marlin.niwa.co.nz/databases>

The data are required to conform to the standards and specifications documented in Section 6 of these instructions: Database *documentation:trawl* business rules and Database *documentation:age* business rules.

It is the responsibility of the research provider to deliver any necessary corrections to the Research Data Manager upon request in a timely manner, until the data are fully compliant with the database specifications. Common errors in *trawl* include:

- incorrect latitude and longitude for pots within a set.
- mismatch between the location of the known fixed site position and the fixed site surveyed.
- mismatch between recorded, and estimated catch from the length of measured fish.
- mismatch between recorded number of fish in the catch and the number measured.
- mismatch between individual fish length and weight.
- incorrect use of units to record environmental data such as wind speed, swell height, etc.
- mismatch between wind force/wind speed/sea condition/swell height.

In addition, random-site *stn\_codes* and locations used on the survey should be provided to the Research Data Manager for loading into *trawl* table *t\_site* at the end of the survey. All possible fixed site *stn\_codes* and locations for all surveys have previously been stored in table *t\_site* and can be cross-checked against the fixed sites that were sampled on a survey.

Only after the data have been error checked by the Research Data Manager and loaded into the *trawl* and *age* databases should the analysis be carried out, and only data extracted from these databases should be used in the analyses. This avoids analyses based on spreadsheets that may contain errors that have not been detected. It also ensures that all persons analysing data from the surveys are using the same datasets.

The *sample\_no* in the *age* database is equivalent to *station\_no* in the *trawl* database.

### 6.2 Data archiving

After data have been error checked, corrected and loaded into the *trawl* and *age* databases, the hard copy forms should be provided to the Research Data Manager for storage.

At the completion of ageing and loading onto the *age* database, all slide preparations and otolith packets, including otoliths not prepared, should be provided to the Research Data Manager for archiving in the otolith library at NIWA, Greta Point.

Extracted ADCP data will be provided to the Research Data Manager in a spreadsheet form for archiving, as well as the software output files generated by the hardware supplier (e.g., RDI instruments). There is currently no Fisheries New Zealand database to store ADCP data.

If strata boundaries have been modified or new strata surveyed, the polygons (or coastline segments) should be provided to the Research Data Manager for archiving. This can be as a series of individual latitude and longitude points, or as shapefiles in WGS84 projection.

## 7. DATA ANALYSIS

The equations documented in this section are from Francis (2011) and are the same as those in Version 1 of the potting manual (Beentjes & Francis 2011).

### 7.1 Catch rates

Relative abundance indices should be calculated as mean catch rates by set ( $\bar{C}_{st}$ ), stratum ( $\bar{C}_t$ ), and survey ( $\bar{C}$ ) (all with units kg/pot) using the following equations.

$$\bar{C}_{st} = \left( \sum_p C_{pst} \right) / m \quad (1)$$

$$\bar{C}_t = \left( \sum_s \bar{C}_{st} \right) / n_t \quad (2)$$

$$\bar{C} = \left( \sum_t A_t \bar{C}_t \right) / \left( \sum_t A_t \right) \quad (3)$$

where  $C_{pst}$  is the catch weight (kg) of all blue cod (or all recruited blue cod – that is, all those above an agreed length at recruitment) in the  $p$ th pot in the  $s$ th set in stratum  $t$ ;  $m$  is the number of pots per set;  $n_t$  is the number of sets in stratum  $t$ ; and  $A_t$  is the area (or coastline length) of that stratum. Note that these indices include no adjustment for soak time.

The precision of the stratum and survey catch rates should be described as a coefficient of variation (CV), calculated using

$$\text{c.v.}(\bar{C}_t) = \left[ \frac{\sum_s (\bar{C}_{st} - \bar{C}_t)^2}{(n_t - 1)n_t} \right]^{0.5} / \bar{C}_t \quad (4)$$

and

$$\text{c.v.}(\bar{C}) = \left[ \sum_t A_t^2 \text{s.e.}(\bar{C}_t)^2 / \left( \sum_t A_t \right)^2 \right]^{0.5} / \bar{C} \quad (5)$$

### 7.2 Length-weight parameters

The length-weight parameters  $a_k$ ,  $b_k$  from a survey are intended for use in the equation

$$w_{ik} = a_k l^{b_k} \quad (6)$$

which calculates the expected weight (kg) for a fish of sex  $k$  and length  $l$  (cm) in the survey catch. These parameters should be calculated from the coefficients of sex-specific linear regressions of log(weight) on log(length) using all fish for which length, weight, and sex were recorded:  $b_k$  is the slope of the regression line, and  $\log(a_k)$  is its  $y$ -intercept.

### 7.3 Scaled length and age frequencies

The following equations describe how to calculate length and age frequencies as numbers of fish. It is straightforward to convert to length/age frequencies expressed as proportions (by dividing by total numbers), which is how the data are generally presented.

For set  $s$  in stratum  $t$ , let  $W_{st}$  be the weight of blue cod caught, and let  $f_{lkst}$  be the number of blue cod of length  $l$  and sex  $k$  in the length sample from the catch (usually this is the whole catch, but it may be a subsample). Then the sex-specific length frequency (LF) for stratum  $t$ , which represents the expected number at length and sex in a set from this stratum, is given by

$$f_{lkt} = (1/n_t) \sum_s^{\text{LF}} \left[ f_{lkst} \left( \frac{W_{st}}{\sum_{l',k'} W_{l'k'st}} \right) \left( \frac{\sum_{s'} W_{s't}}{\sum_{s'}^{\text{LF}} W_{s't}} \right) \right] \quad (7)$$

where  $\sum_s^{\text{LF}}$  denotes a summation restricted to those sets for which there is a length sample.

Equation (7) is complicated because it allows for the possibility that not all blue cod caught in the survey were measured. The third term inside the square brackets can be omitted if there is a length sample from all sets that caught blue cod. The second term inside these brackets can be omitted if all fish were measured in every set with a length sample.

Equation (7) describes how stratum LFs have been calculated historically, using catch weights to correct for any unmeasured fish. The following equation, which makes this correction using numbers of fish rather than fish weight (where  $N_{st}$  is the number of blue cod caught in set  $s$  in stratum  $t$ ), is an acceptable alternative.

$$f_{lkt} = (1/n_t) \sum_s^{\text{LF}} \left[ f_{lkst} \left( \frac{N_{st}}{\sum_{l',k'} f_{l'k'st}} \right) \left( \frac{\sum_{s'} N_{s't}}{\sum_{s'}^{\text{LF}} N_{s't}} \right) \right] \quad (7')$$

The sex-specific survey LF is given by

$$f_{lk} = \frac{\sum_t A_t f_{lkt}}{\sum_t A_t} \quad (8)$$

Sex-specific age frequencies (AFs) at the stratum and survey level are calculated by applying the age-length key,  $K_{lak}$  (where  $K_{lak}$  is the proportion of fish of length  $l$  and sex  $k$  that are of age  $a$  [so  $\sum_a K_{lak} = 1$  for each value of  $k$ ]) in the usual fashion:

$$f_{akt} = \sum_l K_{lak} f_{lkt} \quad \text{and} \quad f_{ak} = \sum_l K_{lak} f_{lk} \quad (9)$$

LFs (or AFs) for sexes combined, at the stratum and survey level, are calculated by summing the sex-specific LFs (or AFs) across sex.

#### Sex ratios, and mean length and ages

Sex ratios (expressed as percentage male) and mean lengths, for either the stratum or survey level, should be calculated in the obvious way from the stratum or survey LFs. Thus, for example, for stratum  $t$  the sex ratio is calculated as

$$100 \sum_l f_{lmt} / \sum_{l,k} f_{lkt} \quad (10)$$

(where the subscript  $m$  denotes males) and the mean length for sex  $k$  as

$$\sum_l l f_{lkt} / \sum_l f_{lkt} \quad (11)$$

Mean ages are calculated analogously from the AFs. For example, the equation for the mean age for sex  $k$  in stratum  $t$  is the same as Equation (11), with  $l$  replaced by  $a$ .

### CVs for LFs and AFs

Bootstrap resampling should be used to allow calculation of CVs for proportions and numbers at length and age. That is to say, simulated data sets should be created by resampling (with replacement) sets from each stratum, and fish from each set (for length and sex information); and also fish from the age-length-sex data that are used to construct the age-length key.

LFs and AFs should be calculated, as described above, for each simulated data set. For any number (or proportion) at age or length,  $f$ , a CV is calculated in the usual way as

$$\text{c.v.}(f) = \sqrt{\frac{\sum_b (f_b - \bar{f})^2}{n_{\text{boot}} - 1}} / \bar{f} \quad (12)$$

where  $f_b$  is the corresponding number (or proportion) calculated from the  $b$ th of  $n_{\text{boot}}$  simulated data sets, and  $\bar{f}$  is the mean of the  $f_b$ .  $n_{\text{boot}} = 300$  has been found to be an adequate number of simulated data sets for this calculation for most data sets.

## 7.4 Total mortality (Z)

For each survey, estimates of total mortality,  $Z$ , should be calculated for six alternative values of the age at recruitment –  $a_{\text{rec}} = 5, 6, 7, 8, 9$  and  $10$  y – using the maximum-likelihood estimator

$$\hat{Z} = \log_e \left( \frac{1 + \bar{a} - a_{\text{rec}}}{\bar{a} - a_{\text{rec}}} \right) \quad (13)$$

where  $\bar{a} = \left( \sum_a^{\text{rec}} a f_a \right) / \left( \sum_a^{\text{rec}} f_a \right)$  is the mean age of recruited fish in the sexes-combined AF for the survey, and  $\sum_a^{\text{rec}}$  denotes summation across all recruited ages.

### CVs for Z estimates

For each age at recruitment,  $a_{\text{rec}}$ , a 95% confidence interval for the associated total mortality estimate,  $\hat{Z}$ , should be calculated using the following simulation procedure, adapted from that of Dunn et al. (2002). This involves drawing a simple random sample of ages from the recruited part of each of 1000 simulated populations in which there is annual variation in  $Z$  (described by a lognormal distribution with mean  $\hat{Z}$  and CV  $c_Z = 0.10$ ) and in recruitment (where log recruitment is normally distributed with standard deviation  $\sigma_R = 0.7$ ). In such a population, the relative frequency of fish at age  $a = 1, \dots, 50$  is given by

$$f_a = e^{-(Z_a + R_a)} \quad (14)$$

where  $Z_a$  is the cumulative mortality defined by

$$Z_1 = 0, \quad Z_a = \sum_{a'=2}^a \hat{Z} d_{a'} \quad (15)$$

the  $d_a$  are lognormally distributed with mean 1 and CV  $c_Z$ , and the  $R_a$  are normally distributed with mean 0 and s.d.  $\sigma_R$ .

With ageing errors assumed to be normally distributed with CV  $c_{\text{age}} = 0.15$ , the relative frequency of fish at *apparent* age  $a$  is given by

$$f'_a = \sum_{a'=1}^{50} f_{a'} E_{a'a} \quad (16)$$

where  $E$  is an ageing-error matrix, calculated by setting  $E_{a'a} = F(a + 0.5, a', c_{\text{age}}) - F(a - 0.5, a', c_{\text{age}})$  [and  $F(x, \mu, c)$  is the cumulative probability function for the normal distribution with mean  $\mu$  and CV  $c$ ] and then normalising the rows of this matrix to sum to 1.

The size,  $n$ , of the sample of ages from the recruited population is calculated, as follows, to mimic the sampling error in the real data. The mean-weighted CV for the recruited part of the real data is calculated as

$$c_{\text{samp}} = \frac{\sum_{a \geq a_{\text{rec}}} f_{a,\text{obs}} c_{a,\text{obs}}}{\sum_{a \geq a_{\text{rec}}} f_{a,\text{obs}}} \quad (17)$$

where  $f_{a,\text{obs}}$  is the AF from the real (unsimulated) data, and  $c_{a,\text{obs}}$  is its CV. The mean-weighted CV is used to calculate  $n$  as

$$n = \left( \frac{\sum_{a \geq a_{\text{rec}}} \sqrt{f_a'' (1 - f_a'')}}{c_{\text{samp}}} \right)^2 \quad (18)$$

where, to maintain consistency in sample sizes across simulated populations, the proportions at age  $f_a''$  are calculated as for the  $f_a$  above, except that  $c_Z$  and  $\sigma_R$  are set to zero; then  $f_a''$  is set to 0 for  $a < a_{\text{rec}}$ , and the  $f_a''$  are normalised to sum to 1.

Finally, a random sample of size  $n$  is selected from the AF  $f_a''$ ; a maximum-likelihood estimate of  $Z$  is calculated from this sample; the set of 1000  $Z$  estimates is scaled to have mean  $\hat{Z}$ ; and the bounds of the 95% confidence interval for  $\hat{Z}$  are set to the 0.025 and 0.975 quantiles of the scaled  $Z$  estimates (the scaling is necessary because the maximum-likelihood estimate can be biased, particularly when there is ageing error).

## 7.5 Spawner per recruit analyses (SPR)

One method to assess the status of blue cod stocks is to estimate fishing mortality, the associated spawner-per-recruit ratio (SPR), and the latter with the Maximum Sustainable Yield (MSY) related proxy. The recommended Harvest Strategy Standard target reference point for blue cod (a low productivity stock) is  $F_{45\% \text{SPR}}$  (Ministry of Fisheries 2011) — i.e., target fishing mortality should be at or below a level that reduces the spawner biomass per recruit ratio to 45% of that when there is no fishing. The calculations are straightforward, and involve simulating fishing with constant fishing mortality,  $F$ , in a population with deterministic recruitment, and determining the equilibrium spawning biomass per recruit (SPR)

associated with that value of  $F$ . The %SPR for that  $F$  is then simply that SPR, expressed as a percentage of the equilibrium SPR when there is no fishing (i.e., when  $F = 0$ ) (Figure 11). The estimate uses the Baranov catch equations which assumes that fishing and natural mortality occur continuously throughout the year.

The following input parameters are needed for this analysis.

|                           |  |
|---------------------------|--|
| Growth parameters         | von Bertalanffy growth parameters and length weight coefficients estimated from the current survey   |
| Natural mortality         | Default $M$ assumed to be 0.17. Sensitivity runs should be carried out for $M$ values 20% above and below the default (0.14 and 0.20). $M$ of 0.17 was based on the empirical age distribution of blue cod from the offshore Banks Peninsula survey in 2016, aged using the blue cod age determination protocol. The $M$ estimate is based on the 1% tail of the distribution, which was 27 years, not the maximum age. $M$ was changed from 0.14 to 0.17 in April 2019 following the recommendation of the Inshore Working Group (SINWG-2019/47). All SPR analyses carried out using 0.14 will need to be recalculated. |
| Maturity ogive            | If possible use a maturity ogive estimated from the survey, otherwise the default maturity ogive is as follows: 0, 0, 0, 0.1, 0.4, 0.7, 1 where 10% of fish are mature at age 4, 40% at age 5 etc.   |
| Selectivity               | Selectivity to the fishery is described as knife-edged at a point equal to the age at the minimum legal size (MLS) for each sex, calculated from the survey von Bertalanffy model. The MLS for this calculation is the MLS for the recreational fishery except for Foveaux Strait surveys where it is the MLS for the commercial fishery.  |
| Fishing mortality ( $F$ ) | Fishing mortality is estimated from the results of the Chapman-Robson $Z$ analyses and the assumed estimate of $M$ (i.e., $F = Z - M$ ). The $Z$ value was for age-at-full recruitment (8 years for females).  |
| Maximum age               | Assumed to be 31 years.  |

## 7.6 Report format

The format of reports and outputs have changed over time and will continue to develop. In general, the format and outputs (figures and tables) for dual fixed-site and random-site surveys will follow that for the most recent North Otago survey in 2018, and for solely random sites surveys the most recent Foveaux Strait survey in 2018 (Beentjes & Fenwick 2019a, Beentjes et al. 2019).

## 8. ACKNOWLEDGMENTS

This research was carried out by NIWA under contract to Fisheries New Zealand (included as objectives in projects BCO201701, BCO201704, BCO201705, and BCO201706). Thanks to Peter Horn (NIWA), and Marc Griffiths (Fisheries New Zealand) for reviewing the manuscript, and Marianne Vignaux for editorial comments.

## 9. REFERENCES

- Beentjes, M.P.; Carbines, G.D. (2003). Abundance of blue cod off Banks Peninsula in 2002. *New Zealand Fisheries Assessment Report 2003/16*. 25 p.
- Beentjes, M.P.; Carbines, G.D. (2005). Population structure and relative abundance of blue cod (*Parapercis colias*) off Banks Peninsula and in Dusky Sound, New Zealand. *New Zealand Journal of Marine and Freshwater Research* 39: 77–90.
- Beentjes, M.P.; Carbines, G.D. (2006). Abundance of blue cod off Banks Peninsula in 2005. *New Zealand Fisheries Assessment Report 2006/1*. 24 p.
- Beentjes, M.P.; Carbines, G.D. (2009). Abundance, size and age composition, and mortality of blue cod off Banks Peninsula in 2008. *New Zealand Fisheries Assessment Report 2009/25*. 46 p.
- Beentjes, M.P.; Carbines, G.D. (2011). Relative abundance, size and age structure, and stock status of blue cod off south Otago in 2010. *New Zealand Fisheries Assessment Report 2011/42*. 60 p.
- Beentjes, M.P.; Carbines, G.D. (2012). Relative abundance, size and age structure, and stock status of blue cod from the 2010 survey in Marlborough Sounds, and review of historical surveys. *New Zealand Fisheries Assessment Report 2012/43*. 137 p.
- Beentjes, M.P.; Fenwick, M. (2017). Relative abundance, size and age structure, and stock status of blue cod off Banks Peninsula in 2016. *New Zealand Fisheries Assessment Report 2017/30*. 81 p.
- Beentjes, M.P.; Fenwick, M. (2019a). Relative abundance, size and age structure, and stock status of blue cod off north Otago in 2018. *New Zealand Fisheries Assessment Report 2019/07*. 55 p.
- Beentjes, M.P.; Fenwick, M. (2019b). Relative abundance, size and age structure, and stock status of blue cod off south Otago in 2018. *New Zealand Fisheries Assessment Report 2019/14*. 47 p.
- Beentjes, M.P.; Francis, R.I.C.C. (2011). Blue cod potting surveys: standards and specifications. Version 1. *New Zealand Fisheries Assessment Report 2011/29*. 47 p.
- Beentjes, M.P.; MacTavish, T.; Fenwick, M. (2017a). Stock status of blue cod in Pohatu and Akaroa Marine Reserves off Banks Peninsula in 2017. NIWA Client Report number 2017356WN. (Unpublished report held by DOC, Akaroa.). 34 p.
- Beentjes, M.P.; Michael, K.; Pallentin, A.; Parker, S.; Hart, A. (2017b). Blue cod relative abundance, size and age structure, and habitat surveys of Marlborough Sounds in 2013. *New Zealand Fisheries Assessment Report 2017/61*. 110 p.
- Beentjes, M.P.; Miller, A. (in prep). Relative abundance, size and age structure, and stock status of blue cod in Paterson Inlet in 2018. *New Zealand Fisheries Assessment Report 2019/XX*. XX p.
- Beentjes, M.P.; Miller, A.; Kater, D. (2019). Relative abundance, size and age structure, and stock status of blue cod in Foveaux Strait in 2018. *New Zealand Fisheries Assessment Report 2019/13*. 52 p.
- Beentjes, M.P.; Page, M. (2016). Relative abundance, size and age structure, and stock status of blue cod in Dusky Sound in 2014. *New Zealand Fisheries Assessment Report 2016/42*. 51 p.
- Beentjes, M.P.; Page, M. (2017). Relative abundance, size and age structure, and stock status of blue cod off Kaikoura in 2015. *New Zealand Fisheries Assessment Report 2017/16*. 54 p.
- Beentjes, M.P.; Page, M. (2018). Relative abundance, size and age structure, and stock status of blue cod off Kaikoura in 2017. *New Zealand Fisheries Assessment Report 2018/37*. 44 p.
- Beentjes, M.P.; Page, M.; Sutton, C.; Olsen, L. (2018). Relative abundance, size and age structure, and stock status of blue cod from the 2017 survey in Marlborough Sounds, and review of historical surveys. *New Zealand Fisheries Assessment Report 2018/33*. 103 p.
- Beentjes, M.P.; Sutton, C. (2017). Relative abundance, size and age structure, and stock status of blue cod off Motunau in 2016. *New Zealand Fisheries Assessment Report 2017/17*. 54 p.
- Blackwell, R.G. (1997). Abundance, size composition, and sex ratio of blue cod in the Marlborough Sounds, September 1995. *NIWA Technical Report 88*. 52 p.
- Blackwell, R.G. (1998). Abundance, size and age composition, and yield-per-recruit of blue cod in the Marlborough Sounds, September 1996. *NIWA Technical Report 30*. 47 p.
- Blackwell, R.G. (2002). Abundance, size and age composition of recruited blue cod in the Marlborough Sounds, September 2001. Final Research Report for Ministry of Fisheries Research Project BCO2001/01. (Unpublished report held by Fisheries New Zealand, Wellington.)



- Blackwell, R.G. (2005). Abundance and size composition of recruited blue cod in the Marlborough Sounds, September 2005. Final Research Report for the Ministry of Fisheries Research Project BCO2003/01. (Unpublished report held by Fisheries New Zealand, Wellington).
- Blackwell, R.G. (2008). Abundance and size composition of recruited blue cod in the Marlborough Sounds, September 2007. Final Research Report for Ministry of Fisheries Research Project BCO2006/01 24 p. (Unpublished report held by Fisheries New Zealand, Wellington.)
- Campana, S.E. (2001). Accuracy, precision, and quality control in age determination, including a review of the use and abuse of age validation methods. *Journal of Fish Biology* 59: 197–242.
- Campana, S.E.; Annand, M.C.; McMillan, J.I. (1995). Graphical and statistical methods for determining the consistency of age determinations. *Transactions of the American Fisheries Society* 124: 131–138.
- Carbines, G.; Haist, V. (2012). Relative abundance, size structure, and stock status of blue cod off Banks Peninsula in 2012. Presentation to the SINS WG. SIN-WG-2012/23. (Unpublished report held by Fisheries New Zealand, Wellington.)
- Carbines, G.; Haist, V. (2014). Relative abundance, size and age structure, and stock status of blue cod in Paterson Inlet of BCO 5 in 2010. *New Zealand Fisheries Assessment Report 2014/14*. 49 p.
- Carbines, G.; Haist, V. (2017a). Relative abundance, population structure, and stock status of blue cod in the Foveaux Strait in 2014. Experimental evaluation of pot catchability and size selectivity. *New Zealand Fisheries Assessment Report 2017/63*. 61 p.
- Carbines, G.; Haist, V. (2017b). Relative abundance, size and age structure, and stock status of blue cod off Banks Peninsula in 2012. *New Zealand Fisheries Assessment Report 2017/37*. 126 p.
- Carbines, G.; Haist, V. (2018a). Relative abundance, population structure, and stock status of blue cod in Paterson Inlet in 2014. Concurrent fixed and random site potting surveys. *New Zealand Fisheries Assessment Report 2018/09*. 59 p.
- Carbines, G.; Haist, V. (2018b). Relative abundance, population structure, and stock status of blue cod off north Otago in 2013. Concurrent fixed and random site potting surveys. *New Zealand Fisheries Assessment Report 2018/07*. 58 p.
- Carbines, G.; Haist, V. (2018c). Relative abundance, population structure, and stock status of blue cod off south Otago in 2013. Estimates of pot catchability and size selectivity. *New Zealand Fisheries Assessment Report 2018/08*. 69 p.
- Carbines, G.D. (2007). Relative abundance, size, and age structure of blue cod in Paterson Inlet (BCO 5), November 2006. *New Zealand Fisheries Assessment Report 2007/37*. 31 p.
- Carbines, G.D. (2017). Establishing a standardised fine mesh potting survey time series to monitor the relative abundance and length frequency of blue cod in the Pohatu Marine Reserve, Banks Peninsula. 25 p. Client report for Department of Conservation Canterbury Conservancy. (Unpublished report held by DOC, Christchurch.)
- Carbines, G.D.; Beentjes, M.P. (2003). Relative abundance of blue cod in Dusky Sound in 2002. *New Zealand Fisheries Assessment Report 2003/37*. 25 p.
- Carbines, G.D.; Beentjes, M.P. (2006a). Relative abundance of blue cod off north Canterbury in 2004–2005. *New Zealand Fisheries Assessment Report 2006/30*. 26 p.
- Carbines, G.D.; Beentjes, M.P. (2006b). Relative abundance of blue cod off North Otago in 2005. *New Zealand Fisheries Assessment Report 2006/29*. 20 p.
- Carbines, G.D.; Beentjes, M.P. (2009). Relative abundance, size and age structure, and mortality of blue cod off north Canterbury (BCO 3) in 2007–08. *New Zealand Fisheries Assessment Report 2009/37*. 56 p.
- Carbines, G.D.; Beentjes, M.P. (2011a). Relative abundance, size and age structure, and stock status of blue cod in Dusky Sound, Fiordland, in 2008. *New Zealand Fisheries Assessment Report 2011/35*. 56 p.
- Carbines, G.D.; Beentjes, M.P. (2011b). Relative abundance, size and age structure, and stock status of blue cod off north Otago in 2009. *New Zealand Fisheries Assessment Report 2011/36*. 57 p.
- Carbines, G.D.; Beentjes, M.P. (2012). Relative abundance, size and age structure, and stock status of blue cod in Foveaux Strait in 2010. *New Zealand Fisheries Assessment Report 2012/39*. 66 p.
- Dunn, A.; Francis, R.I.C.C.; Doonan, I.J. (2002). Comparison of the Chapman-Robson and regression estimators of Z from catch-curve data when non-sampling stochastic error is present. *Fisheries Research* 59: 149–159.

- Francis, R.I.C.C. (1984). An adaptive strategy for stratified random trawl surveys. *New Zealand Journal of Marine and Freshwater Research* 18: 59–71.
- Francis, R.I.C.C. (2011). Data analysis methods for blue cod potting surveys. *New Zealand Fisheries Assessment Report 2011/27*. 30 p.
- Mackay, K.A. (2015). Database documentation: trawl. NIWA Fisheries Data Management Database Documentation Series (revised January 2015). Unpublished document held by NIWA library, Greta Point, Wellington. 38 p.
- McMillan, P.J.; Francis, M.P.; James, G.D. et al. (2019). New Zealand fishes. A field guide to common species caught by bottom, midwater, and surface fishing. *New Zealand Aquatic Environment and Biodiversity* 208. 298 p.
- Ministry of Fisheries (2011). Operational guidelines for New Zealand's harvest strategy standard (Revision 1). 78 p. (Unpublished report held by Fisheries New Zealand, Wellington.)
- Sato, T.; Kobayashi, M.; Takebe, T. et al. (2018). Induction of female-to-male sex change in a large protogynous fish, *Choerodon schoenleinii*. *Marine Ecology* 39:e12484: 1–8.
- Stephenson, P.; Sedberry, G.; Haist, V. (2009). Expert review panel report. Review of blue cod potting surveys in New Zealand. Draft 14 May 2009. BCOREV-2009-22, 14 p. (Unpublished report held by Fisheries New Zealand, Wellington.)
- Walsh, C. (2017). Age determination protocol for blue cod (*Parapercis colias*). *New Zealand Fisheries Assessment Report 2017/15*. 34 p.

## 10. TABLES AND FIGURES

**Table 1: Fisheries New Zealand blue cod potting surveys up to the end of 2018.**

| Survey area        | Survey years                 | Survey design type                  | Pot placement           | References   |
|--------------------|------------------------------|-------------------------------------|-------------------------|--|
| Marlborough Sounds | 1995, 1996, 2001, 2004, 2007 | Fixed-site                          | Directed                | (Blackwell 1997, 1998, 2002, 2005, 2008)                                 |
|                    | 2010                         | Fixed-site and partial Random-site* | Directed and systematic | (Beentjes & Carbines 2012)   |
|                    | 2013                         | Fixed-site and Random-site          | Directed and systematic | (Beentjes et al. 2017b)  |
|                    | 2017                         | Fixed-site and Random-site          | Directed and systematic | (Beentjes et al. 2018)   |
| Kaikoura           | 2004, 2007                   | Fixed-site                          | Directed                | (Carbines & Beentjes 2006a, 2009)  |
|                    | 2011, 2015                   | Fixed-site and Random-site          | Directed and systematic | (Carbines & Haist 2012, Beentjes & Page 2017)                            |
|                    | 2017                         | Random-site                         | Systematic              | (Beentjes & Page 2018)   |
| Motunau            | 2005, 2008                   | Fixed-site                          | Directed                | (Carbines & Beentjes 2006a, 2009)  |
|                    | 2012, 2016                   | Fixed-site and Random-site          | Directed and systematic | (Carbines & Haist 2012, Beentjes & Sutton 2017)                          |
| Banks Peninsula    | 2002, 2005, 2008             | Fixed-site                          | Directed                | (Beentjes & Carbines 2003, 2006, 2009)                                   |
|                    | 2012                         | Fixed-site and Random-site#         | Directed and systematic | (Carbines & Haist 2017b)   |
|                    | 2016                         | Fixed-site and Random-site###       | Directed and systematic | (Beentjes & Fenwick 2017)  |
| North Otago        | 2005, 2009                   | Fixed-site                          | Directed                | (Carbines & Beentjes 2006b, 2011b)                                       |
|                    | 2013, 2018                   | Fixed-site and Random-site          | Directed and systematic | (Carbines & Haist 2018b, Beentjes & Fenwick 2019a)                       |
| South Otago        | 2010                         | Fixed-site and Random-site**        | Directed and systematic | (Beentjes & Carbines 2011)   |
|                    | 2013, 2018                   | Random-site                         | Systematic              | (Carbines & Haist 2018c, Beentjes & Fenwick 2019b)                       |
| Foveaux Strait     | 2010, 2014, 2018             | Random-site                         | Systematic              | (Carbines & Beentjes 2012, Carbines & Haist 2017a, Beentjes et al. 2019) |
| Paterson Inlet     | 2006                         | Fixed-site                          | Directed                | (Carbines 2007)  |
|                    | 2010, 2014                   | Fixed-site and Random-site          | Directed and systematic | (Carbines & Haist 2014, 2018a)   |
|                    | 2018                         | Random-site                         | Systematic              | (Beentjes & Miller in prep)  |
| Dusky Sound        | 2002, 2008                   | Fixed-site                          | Directed                | (Carbines & Beentjes 2003, 2011a)  |
|                    | 2014                         | Fixed-site and Random-site          | Directed and systematic | (Beentjes & Page 2016)   |

\* full fixed-site survey and experimental random-site survey in selected strata.

# random-sites along coastline, with pots set in a line over rocky habitat.

### random-sites within a stratum polygon with pots set systematically in a hexagon shape around the site.

\*\* experimental survey comparing fixed and random-sites within 3 of the 6 strata, and systematic versus directed pot placement within each set.

**Table 2: Blue cod potting surveys within marine reserves up to the end of 2018. DOC, Department of Conservation; FishNZ, Fisheries New Zealand; NIWA, National Institute of Water and Atmospheric Research Ltd. All survey data are in the Fisheries New Zealand *trawl* database. Fisheries New Zealand funded marine reserve surveys are part of the wider area surveys (see Table 1).**

| Survey area        | Marine Reserve  | Survey year | Strata          | Trip code        | Survey design type         | Pot placement           | Funder   | References                     |
|--------------------|---|-------------|-----------------|------------------|----------------------------|-------------------------|----------|--------------------------------|
| Dusky Sound        | Taumoana Marine Reserve                               | 2008        | MR              | GOL0801          | Fixed-site                 | Directed                | FishNZ   | (Carbines & Beentjes 2011a)    |
|                    |   | 2014        | MR              | WEX1401          | Fixed-site and random-site | Directed and systematic | FishNZ   | (Beentjes & Page 2016)         |
| Banks Peninsula    | Pohatu Marine Reserve (and adjacent strata)           | 2008        | PO, 2, 3        | CHJ0802          | Fixed-site                 | Directed                | DOC      | (Carbines 2017)                |
|                    | Pohatu Marine Reserve                                 | 2012        | PO              | CHJ1202          | Fixed-site*                | Directed                | DOC      | (Carbines 2017)                |
|                    | Pohatu and Akaroa Marine Reserves and adjacent strata | 2017        | PO, 2BW, 2AW, 3 | CHJ1701          | Random-site                | Systematic              | DOC/NIWA | (Beentjes et al. 2017a)        |
| Marlborough Sounds | Long Island Marine Reserve                            | 2017        | 14              | IKA1701          | Random-site                | Systematic              | FishNZ   | (Beentjes et al. 2018)         |
| Paterson Inlet     | Ulva Island Marine Reserve                            | 2006        | 3               | GOL0601          | Fixed-site                 | Directed                | FishNZ   | (Carbines 2007)                |
|                    |   | 2010, 2014  | 3               | WEX1001, FRA1402 | Fixed-site and random-site | Directed and systematic | FishNZ   | (Carbines & Haist 2014, 2018a) |
|                    |   | 2018        | 3               | PRO1802          | Random-site                | systematic              | FishNZ   | (Beentjes & Miller in prep)    |

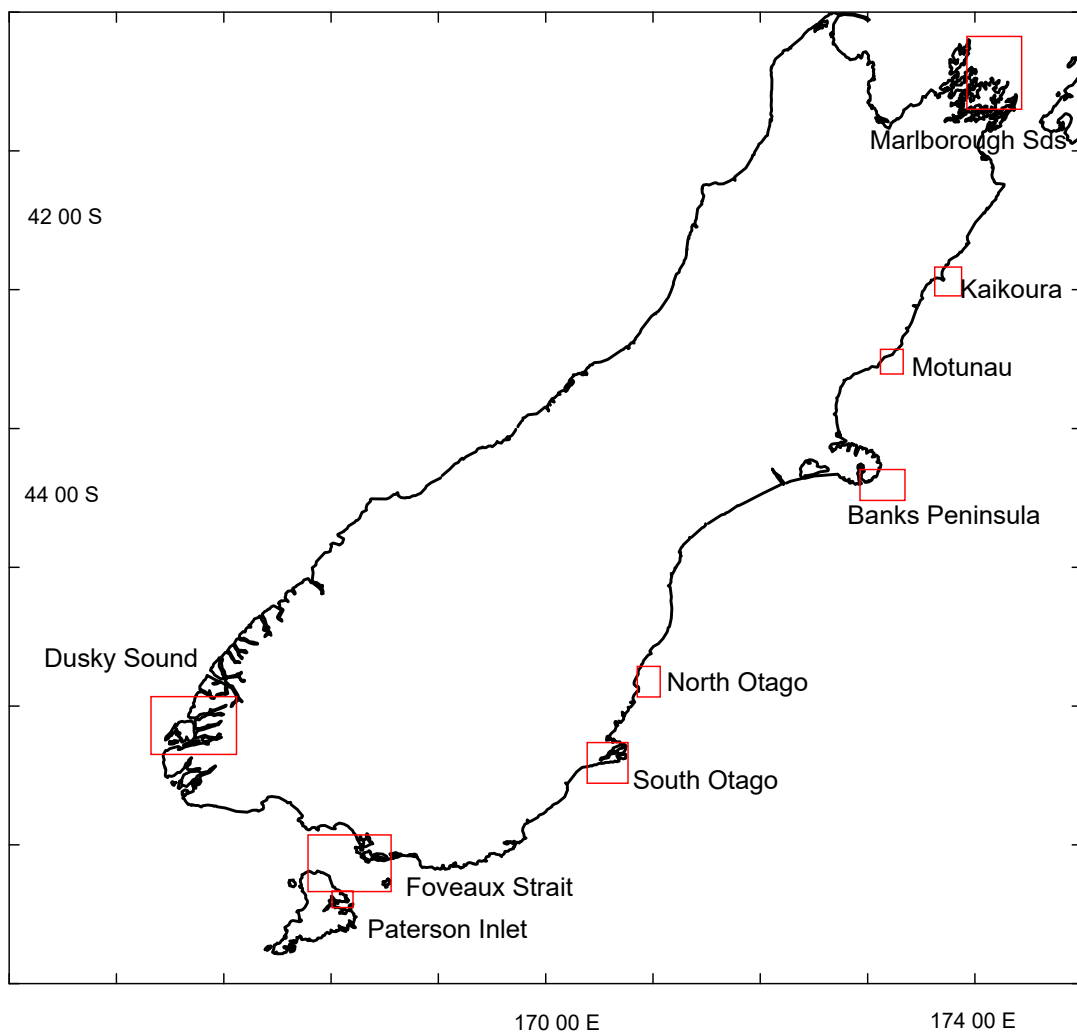
\* reclassified as fixed-site design

**Table 3: Trip codes (*trip\_code*), station numbers (*station\_no*) and station codes (*stn\_code*) for Fisheries New Zealand blue cod potting surveys up to the end of 2018. Station number is formed by concatenating the set number with the pot number, station codes are formed by concatenating the stratum code with an alpha or numeric label (A–Z, or 1 to 9) that is unique within that stratum. Station codes with an R (e.g., R12 or 1R1) indicates that this is a random-site, otherwise it is a fixed-site. Exceptions: 1) for some surveys the set number has been used as the station code, and random sites in this case are identified by an ‘S’ (systematic pot placement) and fixed sites by a ‘D’ (directed pot placement) in character two of *t\_station* attribute *categories*; 2) Marlborough Sounds 1995–2007 surveys station numbers are equal to the sequential pot or line number, and station codes have a suffix (a–i) that identifies the nine pots in the set. All station numbers with a 0 suffix represent ADCP locations. See trip comments in *t\_trip* and published reports for further explanation of these attributes for each survey.**

| Survey                    | trip_code | station_no  | stn_code (examples)   |
|---------------------------|-----------|---|---|
| <b>Marlborough Sounds</b> |           |   |   |
| 1995                      | LHR9501   | Sequential pot number 1 to 388<br>Sequential line number 900 to 958             | Unsure of how defined in trawl database<br>Unsure of how defined in trawl database  |
| 1996                      | LHR9601   | Sequential pot number 1 to 208<br>Sequential line number 901 to 999             | Unsure of how defined in trawl database<br>Unsure of how defined in trawl database  |
| 2001                      | LHR0101   | Sequential pot number 1 to 377<br><br>Sequential line number 901 to 984         | Pots: 1A1a, 1A1b, 1A1c, 1A2a, 1A2b, 1A2c, 1A3a, 1A3b, 1A3c, 1B1a, 1B1b...<br>Lines: 1A1g, 1A2g, 1B1g, 1B3g...             |
| 2004                      | LHR0401   | Sequential pot number 1 to 585<br><br>Sequential line number 900 to 1029        | Pots: 1A1a, 1A1b, 1A1c, 1A1d, 1A1e, 1A1f, 1A1g, 1A1h, 1A1i, 1B1a, 1B1b, 1B1c, 1B1d...<br>Lines: 1A1j, 1A1k, 1B1j, 1B1k... |
| 2007                      | LHR0701   | Sequential pot number 1 to 706<br><br>Sequential line number 900 to 1046        | Pots: 1A1a, 1A1b, 1A1c, 1A1d, 1A1e, 1A1f, 1A1g, 1A1h, 1A1i, 1B1a, 1B1b, 1B1c, 1B1d...<br>Lines: 1A1j, 1A1k, 1B1j, 1B1k... |
| 2010                      | LHR1001   | Set – pot number (range 11 to 839)  | 1A, 1B, 2A, 2B, R4A, R4B, R5A, R5B...   |
| 2013                      | IKA1301   | Set – pot number (range 11 to 1039).<br>Pot selectivity comparisons (1040–1118) | 1A, 1B, 2A, 2B, R4A, R4B, R5A, R5B...<br>PC1, PC2, PC3...   |
| 2017                      | IKA1704   | Set – pot number (range 11 to 1189)   | 1A, 1B, 2A, 2B, R4A, R4B, R5A, R5B...   |
| <b>Kaikoura</b>           |           |   |   |
| 2004                      | MYS0401   | Set – pot number (range 11 to 256)  | 1A, 1B, 2A, 2B...   |
| 2007                      | MYS0701   | Set – pot number (range 11 to 256)  | 1A, 1B, 2A, 2B...   |
| 2011                      | MYS1101   | Set – pot number (range 11 to 496)  | 1–49 (= set number). Random-sites have ‘S’ and fixed sites ‘D’ in character 2 of <i>categories</i>                        |
| 2015                      | MYS1501   | Set – pot number (range 11 to )   | 2A, 2B, 3A, 3B; R21, R22, R31, R32 etc  |
| 2017                      | IKA1706   | Set – pot number (range 11 to 346)  | R2A, R2B, R31, R32...   |

| Survey                 | trip_code           | station_no  | stn_code (examples)  |
|------------------------|---------------------|---|--|
| <b>Motunau</b>         |                     |   |  |
| 2005                   | NAV0501             | Set – pot number (range 11 to 196)  | 1A, 1B, 2A, 2B...  |
| 2008                   | LEG0801             | Set – pot number (range 11 to 206)  | 1A, 1B, 2A, 2B...  |
| 2012                   | NAV1201             | Set – pot number (range 11 to 396)  | 1–39 (= set number). Random-sites have ‘S’ and fixed sites ‘D’ in character 2 of <i>categories</i> |
| 2016                   | NAV1601             | Set – pot number (range 11 to 396)  | 2A, 2B, 3A, 3B; R21, R22, R31, R32...  |
| <b>Banks Peninsula</b> |                     |   |  |
| 2002                   | CHJ0201             | Set – pot number (range 11 to 426)  | 1A, 1B, 2A, 2B...  |
| 2005                   | CHJ0501             | Set – pot number (range 11 to 406)  | 1A, 1B, 2A, 2B...  |
| 2008                   | CHJ0801             | Set – pot number (range 11 to 406)  | 1A, 1B, 2A, 2B...  |
| 2012                   | CHJ1201             | Set – pot number (range 11 to 426)  | 1A, 1B, 2A, 2B; 1R1, 1R2, 2R1, 2R2...  |
| 2016                   | CHJ1601             | Set – pot number (range 11 to 806)  | 1A, 1B, 2A, 2B; R11, R12, R21, R22...  |
| <b>North Otago</b>     |                     |   |  |
| 2005                   | SUZ0501             | Set – pot number (range 11 to 346)  | 1A, 1B, 2A, 2B...  |
| 2009                   | NIM0901             | Set – pot number (range 11 to 376)  | 1A, 1B, 2A, 2B...  |
| 2013                   | TRI1301             | Set – pot number (range 11 to 676)  | 1A, 1B, 2A, 2B; 1R1, 1R2, 2R1, 2R2...  |
| 2018                   | TRI1801             | Set – pot number (range 11 to 676)  | 1A, 1B, 2A, 2B; R11, R12, R21, R22...  |
| <b>South Otago</b>     |                     |   |  |
| 2010                   | TRI1001             | Set – pot number (range 11 to 366).   | 1A, 1B, 2A, 2B; R1B, R1C, R3L, R3M...  |
| 2013                   | TRI1302             | Set – pot number (range 11 to 406).   | 2R1, 2R2, 3R1, 3R2 ...   |
| 2018                   | TRI1802,<br>CHV1801 | Set – pot number (range 11 to 436).   | R1A, R1B, R2A, R2B...  |
| <b>Foveaux Strait</b>  |                     |   |  |
| 2010                   | THE1001             | Set – pot number (range 11 to 566)  | 1–56 (= set number).   |
| 2014                   | FRA1401             | Set – pot number (range 11 to 616)<br>Pot selectivity comparisons (901–940) | 1–61 (= set number).   |
| 2018                   | PRO1801             | Set – pot number (range 11 to 386)  | R1A, R1B, R2A, R2B...  |

| Survey                | trip_code | station_no                         | stn_code (examples)  |
|-----------------------|-----------|------------------------------------|--|
| <b>Paterson Inlet</b> |           |                                    |  |
| 2006                  | GOL0601   | Set – pot number (range 11 to 346) | 1A, 1B, 2A, 2B etc   |
| 2010                  | WEX1001   | Set – pot number (range 11 to 646) | 1A, 1B, 2A, 2B; 1R1, 1R2, 2R1, 2R2...  |
| 2014                  | FRA1402   | Set – pot number (range 11 to 635) | 1–63 (= set number). Random-sites have ‘S’ and fixed sites ‘D’ in character 2 of <i>categories</i> . |
| 2018                  | PRO1802   | Set – pot number (range 11 to 416) | R1A, R1B, R2A, R2B...  |
| <b>Dusky Sound</b>    |           |                                    |  |
| 2002                  | SLT0201   | Set – pot number (range 10 to 445) | eo1, eo2, ou1, ou2...  |
| 2008                  | GOL0801   | Set – pot number (range 10 to 546) | EO1, EO2, OU1, OU2...  |
| 2014                  | WEX1401   | Set – pot number (range 10 to 626) | EO1, EO2, OU1, OU2; REO1, REO2, ROU1, ROU2...  |



**Figure 1: Nine South Island blue cod potting survey locations.**





**Figure 2: One of the nine pots used in Marlborough Sounds blue cod potting surveys. This was built using Pot Plan 1 specifications. (Photo by Ron Blackwell.)**

### **General specifications for Pot Plan 1**

1. Main frame – 10 mm diameter HRC steel rod.
2. Heavy base frame – 30 mm diameter steel.
3. Protective 8 mm rope looped around entire frame.
4. Diamond-shaped trawl mesh (60 mm × 40 mm × 2 mm thick) covering entire frame.
5. Wire “chicken mesh” (22 mm × 14 mm) covering the base and partial sides (470 mm height). Top of mesh is attached to the frame with 2 mm cord extending around entire pot. This mesh is interior to the trawl mesh.
6. 100 mm shark clip attached to base of pot. This is used to attach the baited “snifter pot”.
7. 8 mm rope used to fasten hinged door.
8. Door hinges – 20 mm diameter tube steel.

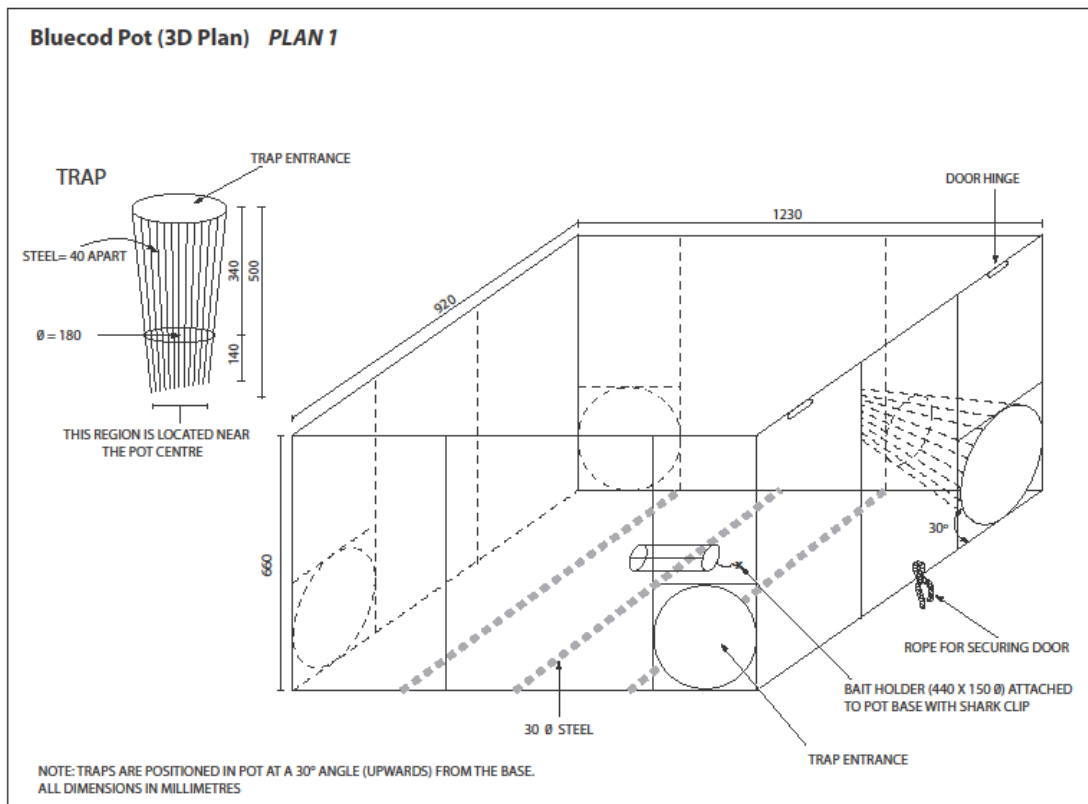
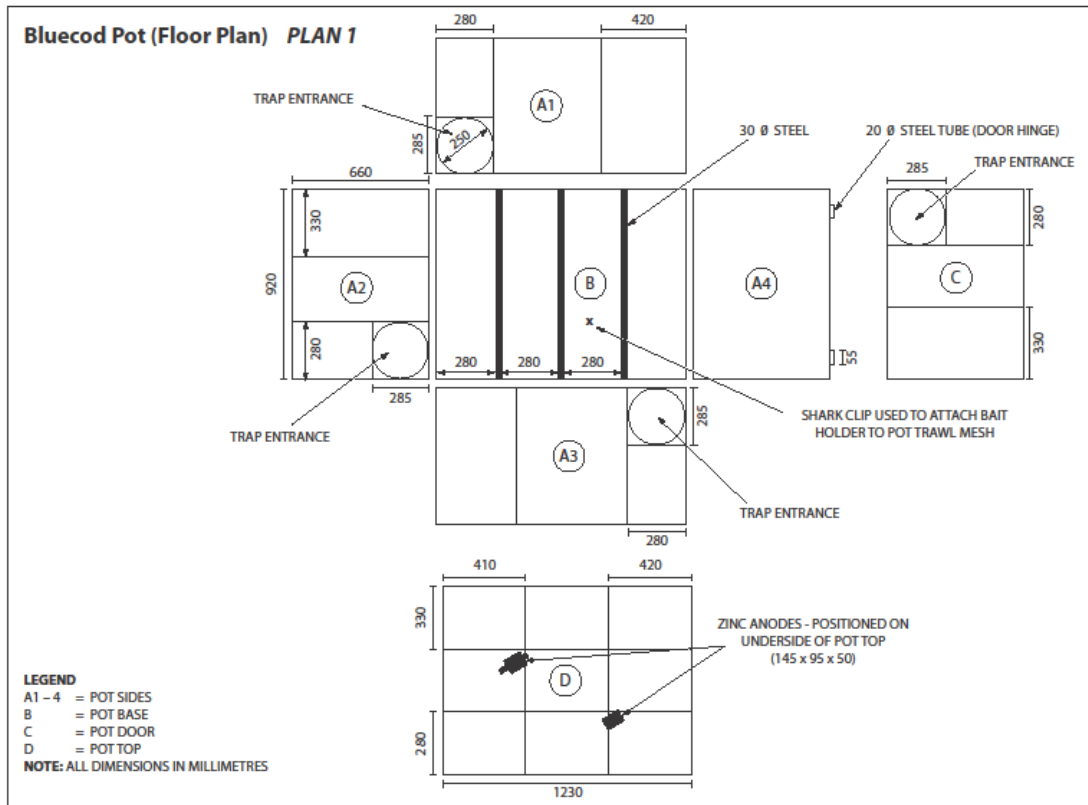


Figure 3: Floor plan and 3D plan for Pot Plan 1 (Marlborough Sounds pot).





**Figure 4: One of the six pots used in blue cod South Island potting surveys (other than Marlborough Sounds). This was built using Pot Plan 2 specifications. (Photo by Mark Fenwick.)**

### **General specifications for Pot Plan 2**

1. Main frame – 16.5 mm diameter steel rod.
2. Base runners – 16.5 mm diameter steel
3. Diamond-shaped trawl mesh (25 mm KTK, 2.0 mm yarn) covering entire frame.
4. Expanding (diamond) wire mesh (75 mm × 75 mm) covers entire frame. Wire mesh is laced to frame with s/s wire. This mesh is exterior to the trawl mesh.
5. Automotive tube rubber and steel hook (10 mm rod) used to fasten hinged door.
6. Buoy rope bridle is 12.5 mm polypropylene rope.
7. Door hinges – 28 mm (o/d) tube steel, 3.5 mm wall.
8. 2 (140 mm × 100 mm × 50 mm) zinc anodes welded to frame
9. Trap cones constructed of 13 mm rings and 6.2 mm bars. Frame is not galvanised.
10. Snifter pottle holder is welded in situ (13 mm steel rod) – in a form that accepts a commercially produced polyethylene tube type snifter which is retained by automotive tube rubber and a steel hook.

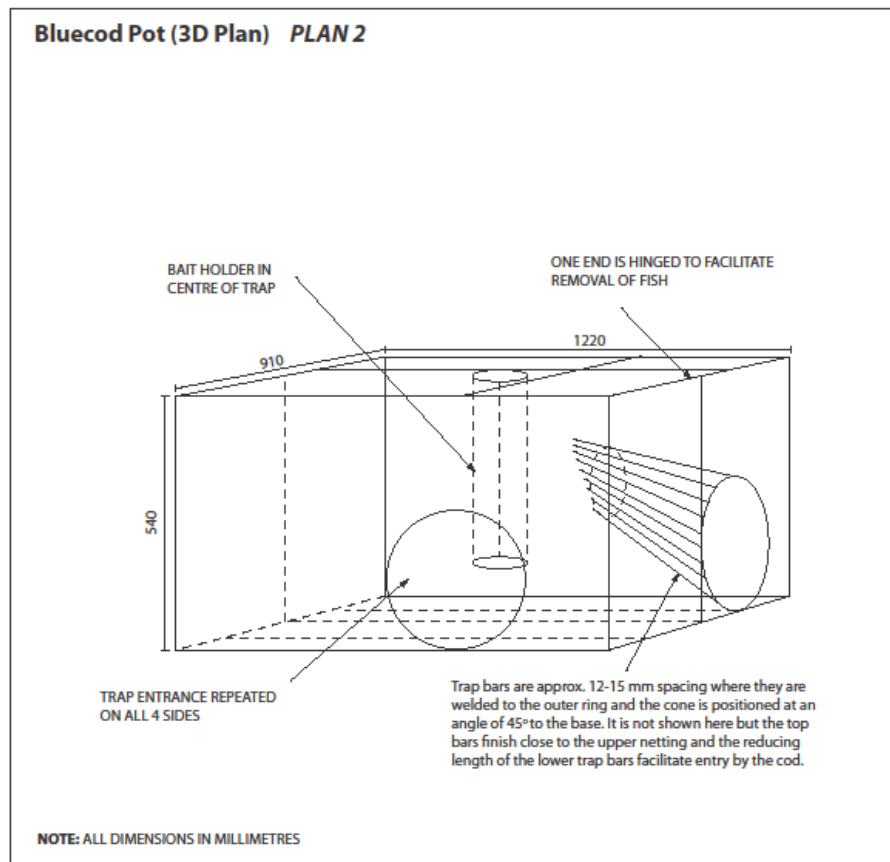
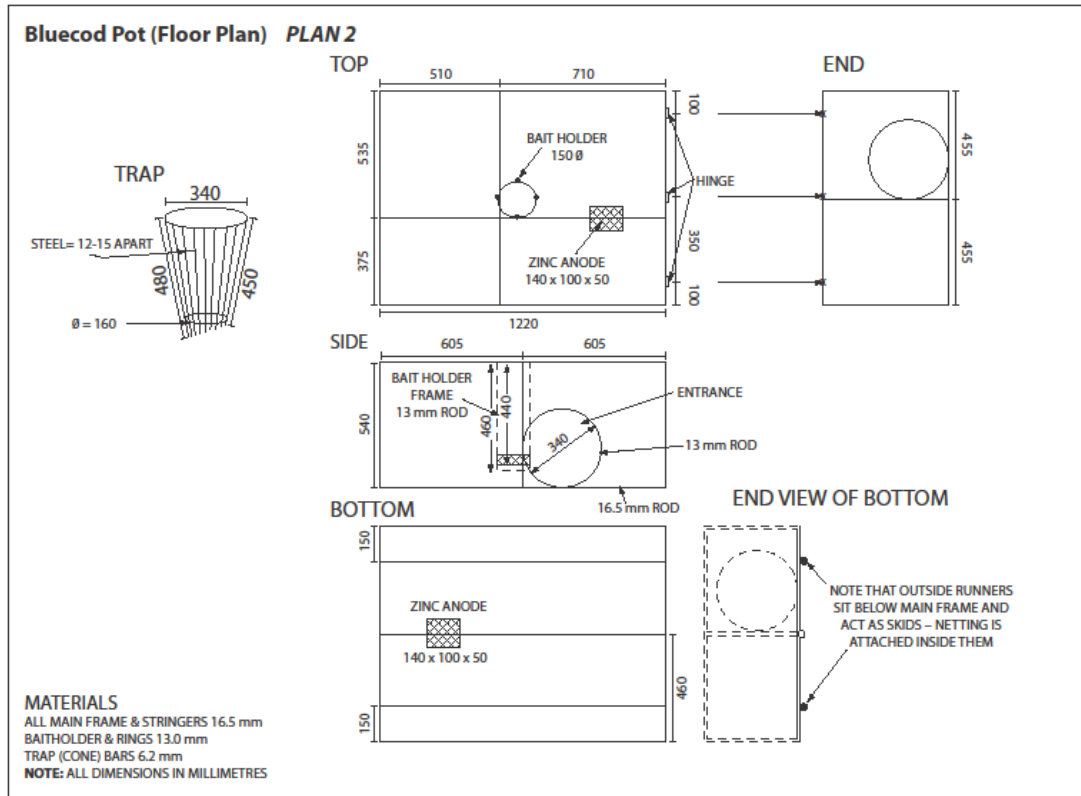
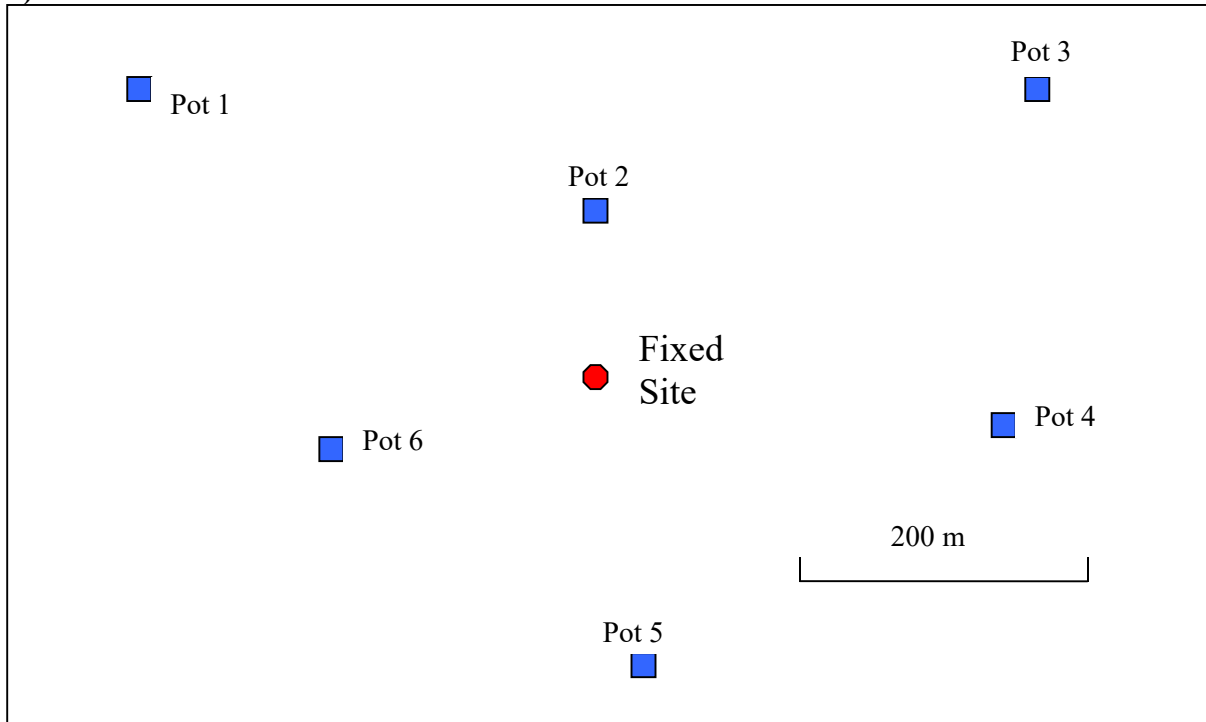
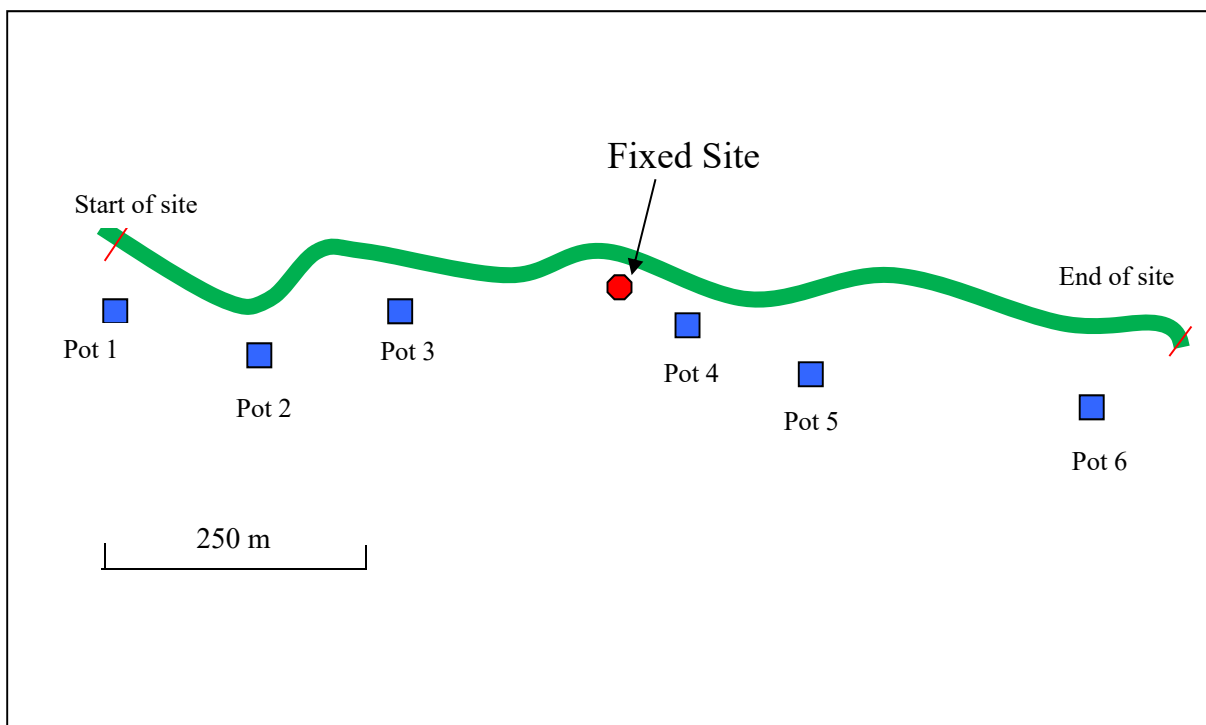


Figure 5: Floor plan and 3D plan of Pot Plan 2 (South Island surveys excl. Marlborough Sounds).

a)

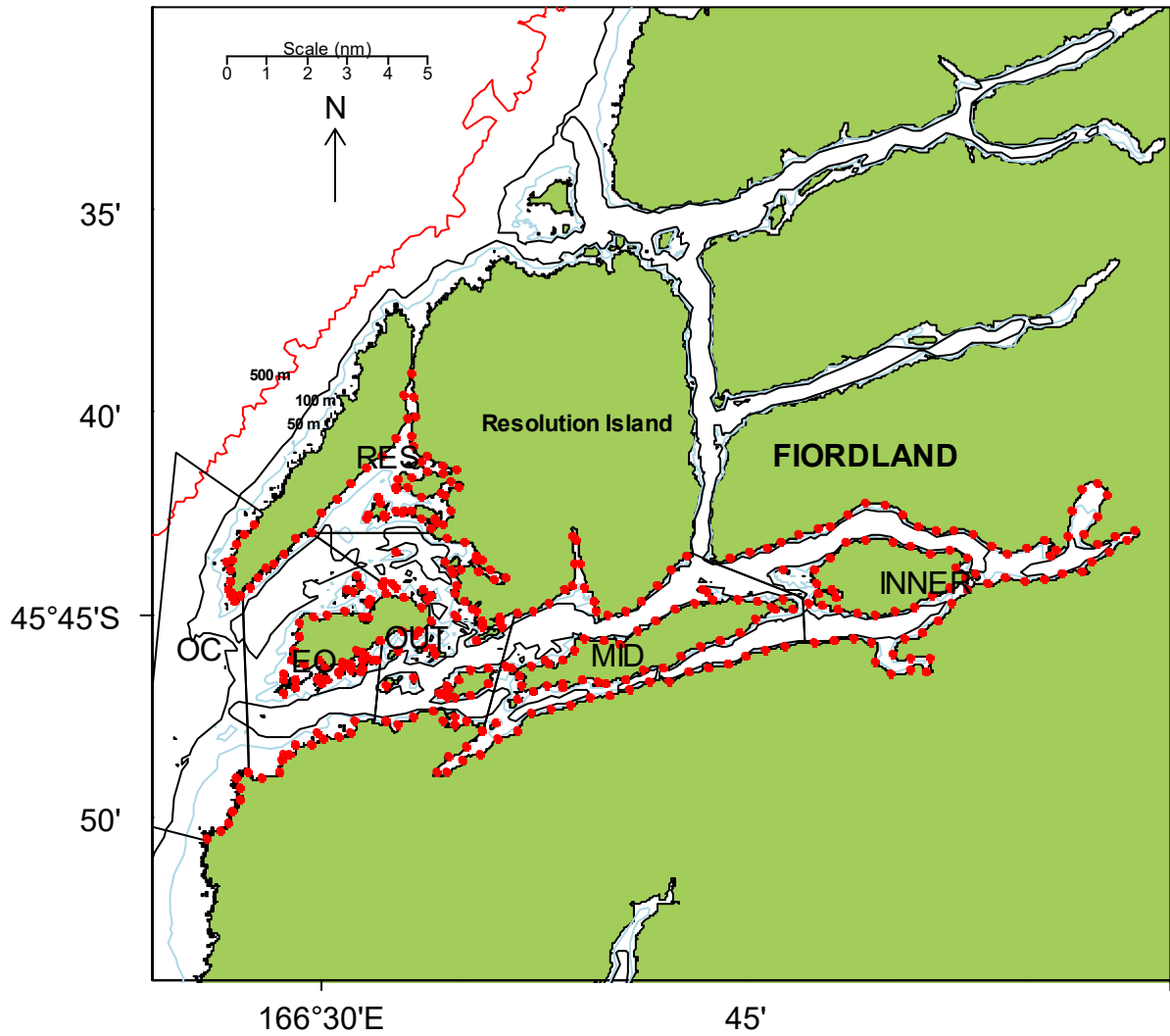


b)

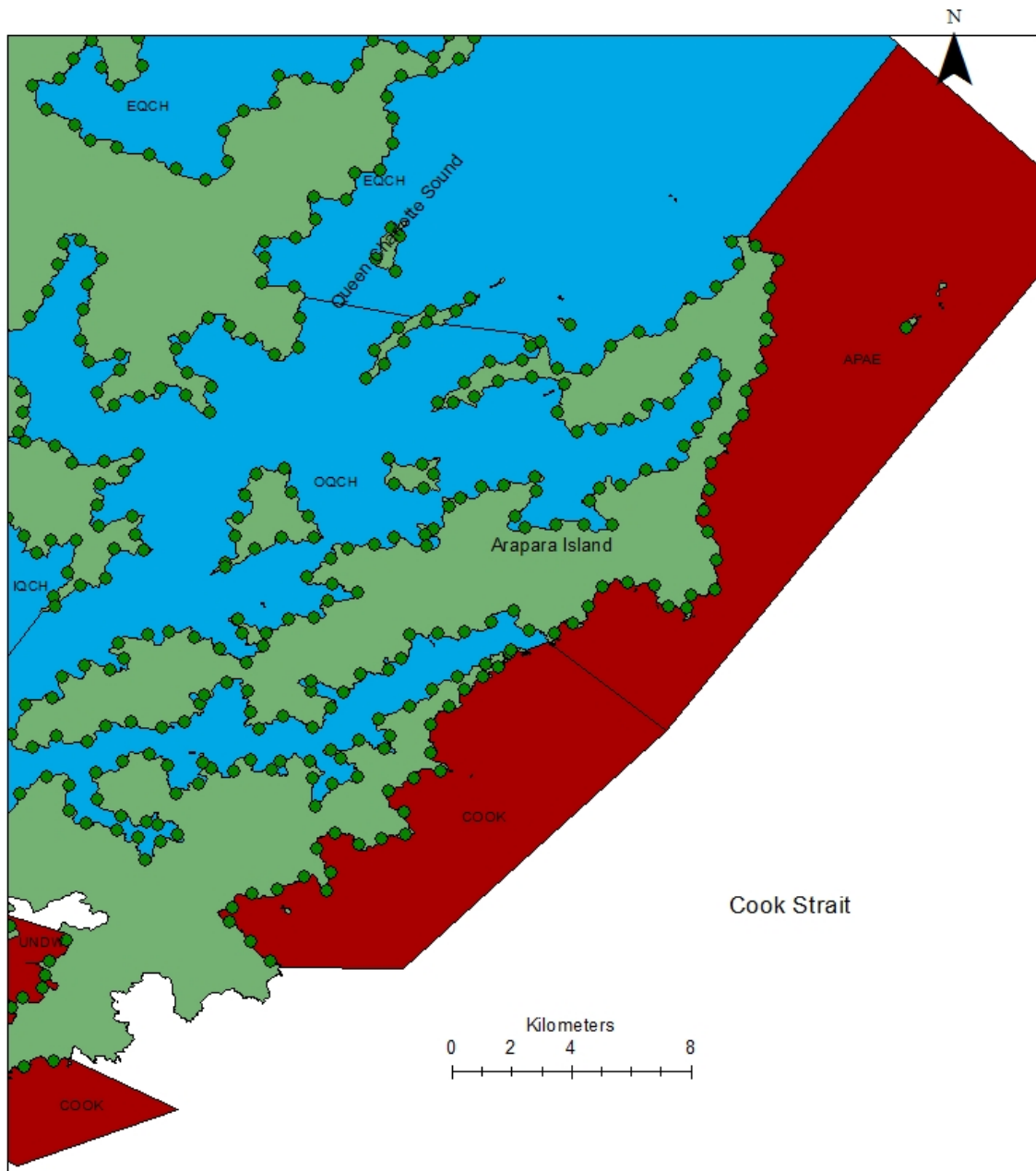


**Figure 6. Graphical representation of the two types of directed pot placement in a set for fixed-site surveys; a) pots are set in a cluster around a site at least 100 m apart but no more than 0.5 km from the site; b) pots are set along a section of coast around a site at least 100 m apart (Marlborough Sounds surveys use 9 pots in a set). In both a) and b) the position of each pot is determined by the skipper using local knowledge and the vessel echo sounder to locate a suitable area of reef/cobble or biogenic habitat.**

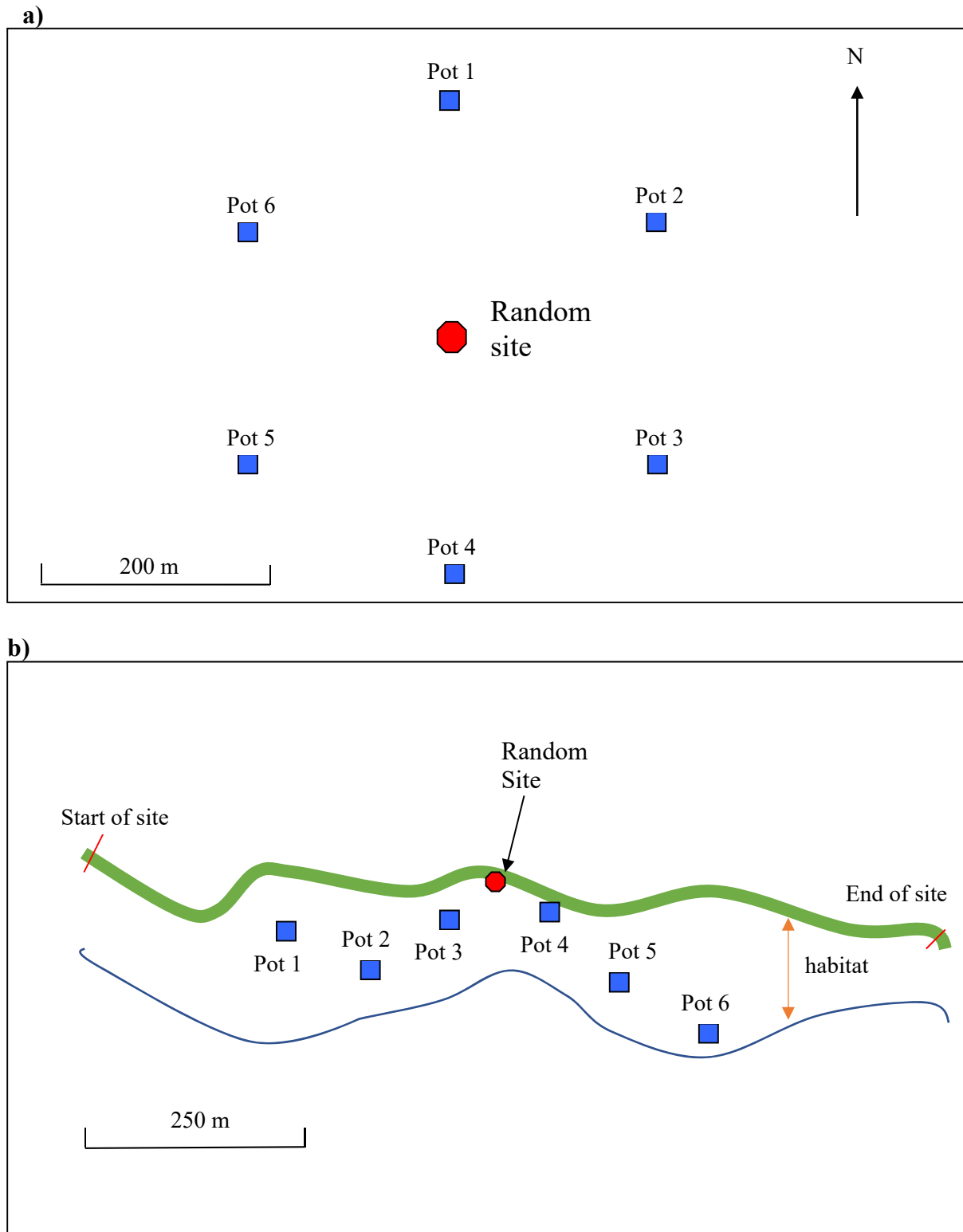
### All possible random sites



**Figure 7: All possible random sites in Dusky Sound survey area. The red dots represent a latitude and longitude at the centre of a 1.01 km coastline segment (N = 364).**

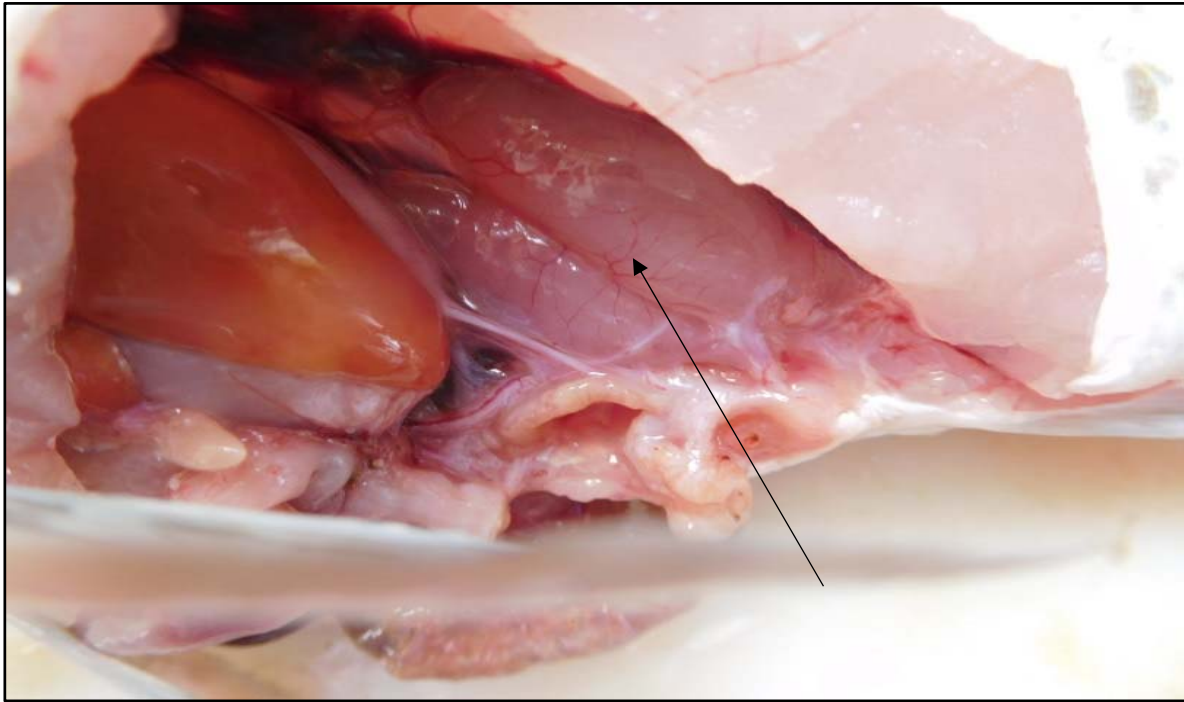


**Figure 8: All possible random sites in part of Queen Charlotte Sound and Cook Strait strata of Marlborough Sounds survey area. The green dots represent a latitude and longitude at the centre of a 1.01 km coastline segment (N = 1195 for the entire Marlborough Sounds).**



**Figure 9: Graphical representation of the two types of systematic pot placement in a set for random-site surveys. a) The first of six pots is placed 200 m to the north of the site location and remaining pots are placed in a hexagonal pattern around the site, 200 m from the site position; b) Six pots are set along the shoreline every 100 m, starting from a point 250 m from the site position, in a randomly selected depth over the extent of the habitat, as it extends out perpendicular from the shore. For Marlborough Sounds surveys, 9 pots are used in a set and the starting point is 450 m from the random site position.**





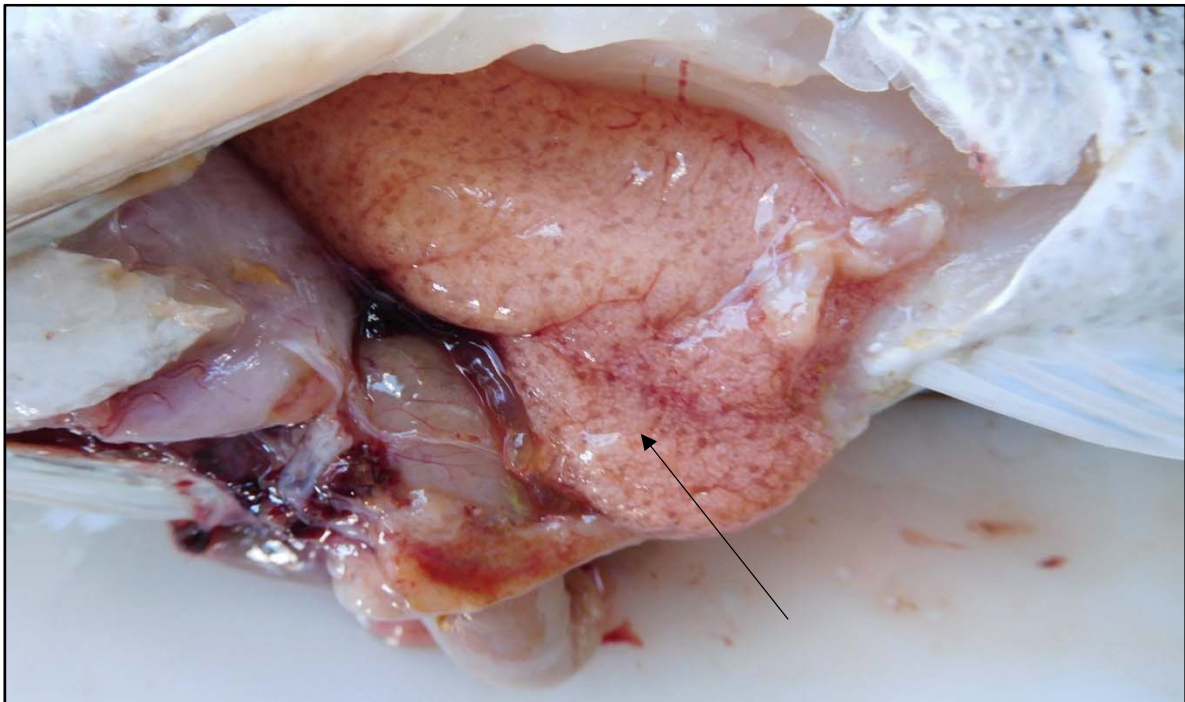
**Female stage 1** (immature or resting): Ovaries are small, elongated, gelatinous and typically pink in colouration (no oocytes present).



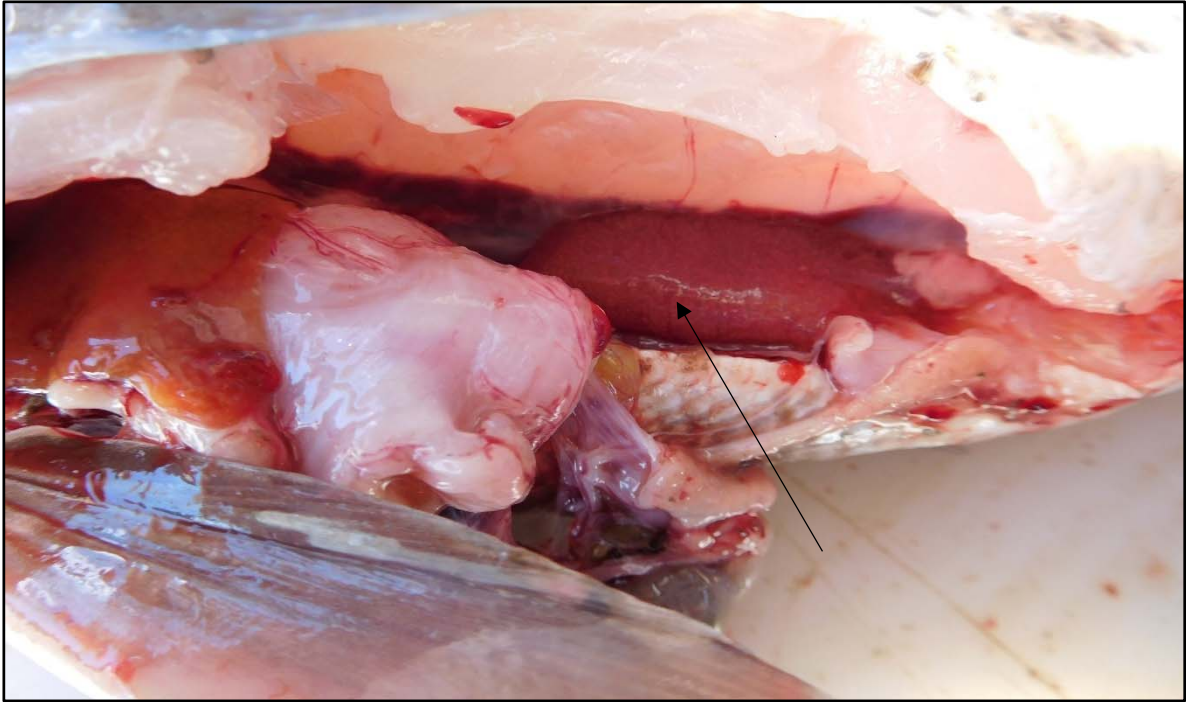
**Female stage 2** (maturing): Ovaries are slightly larger than stage 1 with opaque oocytes present.



**Female stage 3 (mature):** Ovaries have some translucent hyaline oocytes visible.



**Female stage 4 (running ripe):** Oocytes free-flowing when fish is squeezed. Ovaries appear very similar to stage 3 when dissected.

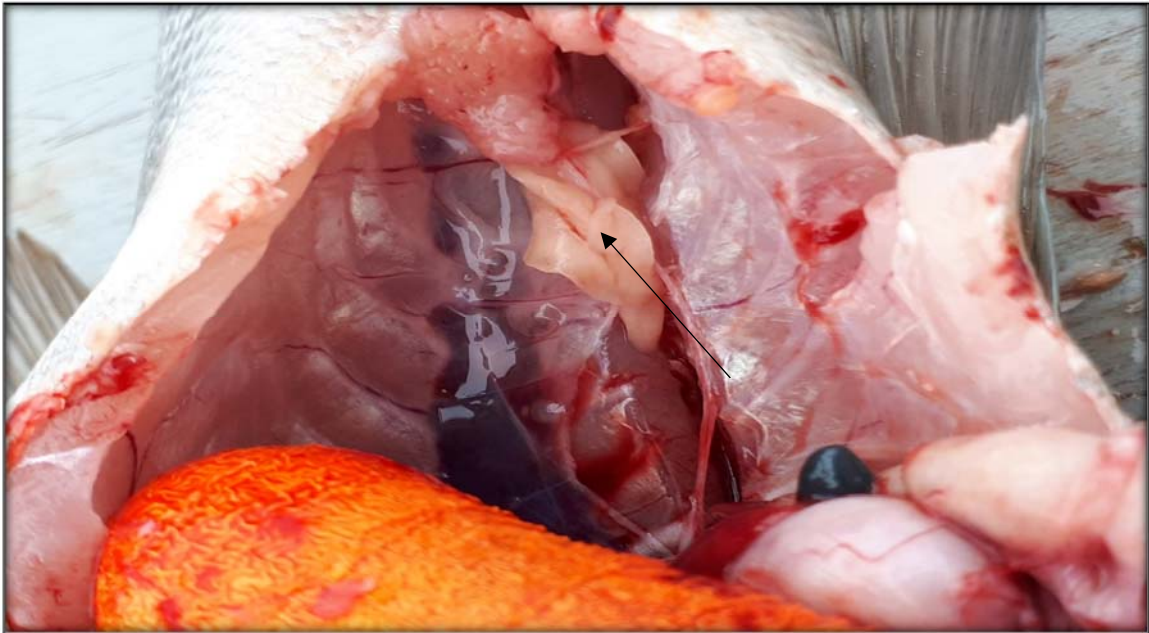


**Female stage 5 (spent):** Ovaries bloody and thick. Residual oocytes may be present.

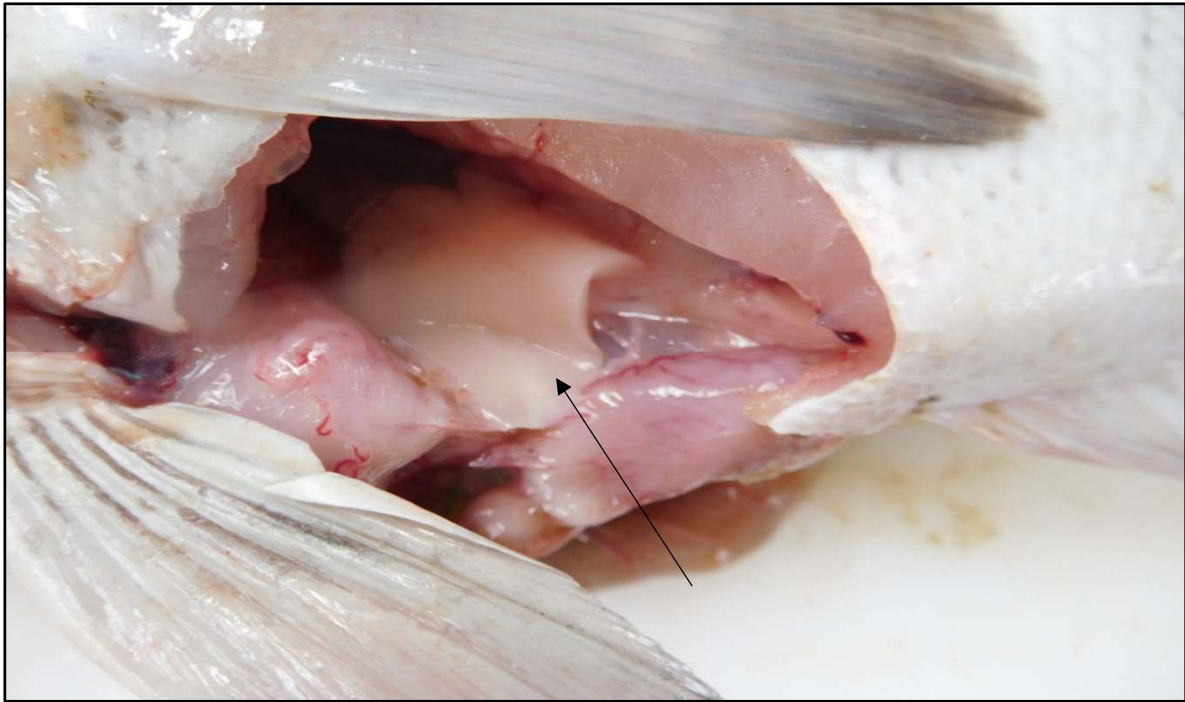




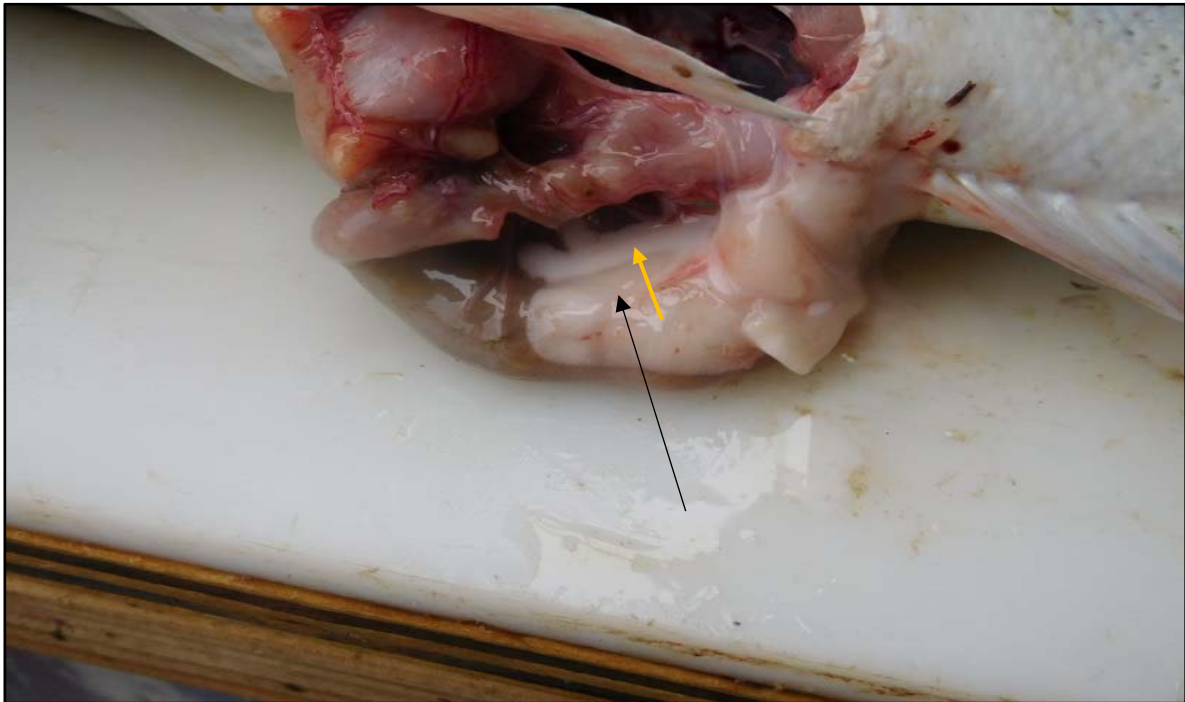
**Male stage 1** (immature or resting): Testes are small, thin and thread-like in appearance.



**Male stage 2** (maturing): Small white testes with some lobes present (not thread-like). No milt present.



**Male stage 3 (mature):** Testes white (milt present when squeezed but not free-flowing).

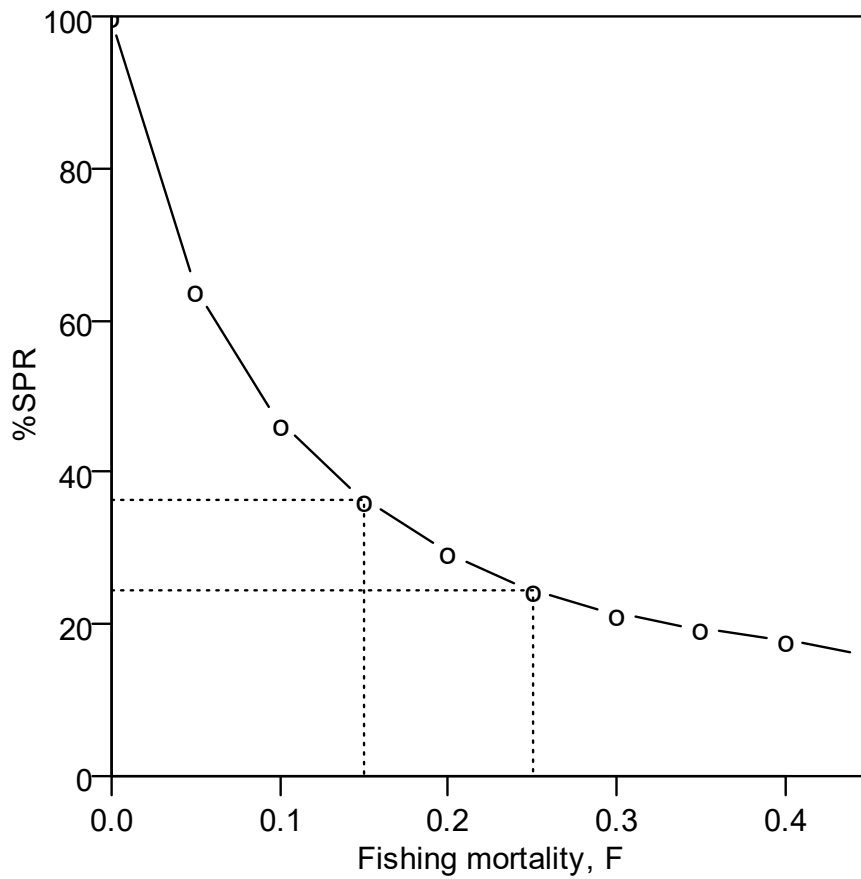


**Male stage 4 (running ripe):** Testes large, white and milt (shown by yellow arrow) is free flowing.



**Male stage 5 (spent):** Testes show some browning and surface structure is less consistently smooth than evident in stage 3 and 4 (residual milt may be present).

**Figure 10: Blue cod five-stage stock monitoring gonad staging guide.**



**Figure 11: An example of a plot of spawner biomass per recruit (%SPR) as a function of fishing mortality from two hypothetical surveys. The dotted lines indicate the fishing mortality (F) for each survey (0.15 and 0.25) and the corresponding %SPR (37% and 25%).**

# 11. APPENDICES

## Appendix 1: Blue cod potting survey at-sea recording forms.

### BLUE COD POTTING SURVEY TRIP RECORD (2018 edition)

trip\_code \_\_\_\_\_

| Vessel | Year | No. |
|--------|------|-----|
|        |      |     |

|        |       |
|--------|-------|
| Leader | _____ |
| Master | _____ |

|      |       |
|------|-------|
| Area | _____ |
|------|-------|

|         |       |
|---------|-------|
| Stratum | _____ |
|---------|-------|

|                    |       |
|--------------------|-------|
| Stratum area codes | _____ |
|--------------------|-------|

|              |       |
|--------------|-------|
| Main species | _____ |
|--------------|-------|

Pot plan    Pots per set

|       |       |
|-------|-------|
| _____ | _____ |
|-------|-------|

|       |       |
|-------|-------|
| Staff | _____ |
|       | _____ |

|               |       |
|---------------|-------|
| Trip comments | _____ |
|               | _____ |
|               | _____ |
|               | _____ |

Trip dates \_\_\_\_\_

|        | Day | Month | Year |
|--------|-----|-------|------|
| Start  |     |       |      |
| Finish |     |       |      |

Page \_\_\_ of \_\_\_

RECORDER \_\_\_\_\_

Project code \_\_\_\_\_



## BLUE COD POTTING SURVEY SET RECORD (2018 edition)

trip\_code

| Vessel | Year | No. | Area |
|--------|------|-----|------|
|        |      |     |      |

Date

| Day | Month | Year |
|-----|-------|------|
|     |       |      |

Page \_\_\_ of \_\_\_

RECORDER \_\_\_\_\_

Site type Set number stn\_code Stratum Phase

|   |   |  |  |  |  |
|---|---|--|--|--|--|
| F | R |  |  |  |  |
|---|---|--|--|--|--|

Gear method

| Code | No. of units |
|------|--------------|
|      |              |

ADCP data

|     |    |
|-----|----|
| yes | no |
|-----|----|

| Pot number | Pot place. | Time (NZST) |        | Method of fix | Latitude |         |  | N/S | Longitude |         | E/W | Gear      |                  |
|------------|------------|-------------|--------|---------------|----------|---------|--|-----|-----------|---------|-----|-----------|------------------|
|            |            | Start       | Finish |               | Degrees  | Minutes |  |     | Degrees   | Minutes |     | Depth (m) | Perf. %Bait left |
|            |            |             |        | 08            | 4        |         |  | S   | 1         |         |     |           |                  |
|            |            |             |        | 08            | 4        |         |  | S   | 1         |         |     |           |                  |
|            |            |             |        | 08            | 4        |         |  | S   | 1         |         |     |           |                  |
|            |            |             |        | 08            | 4        |         |  | S   | 1         |         |     |           |                  |
|            |            |             |        | 08            | 4        |         |  | S   | 1         |         |     |           |                  |
|            |            |             |        | 08            | 4        |         |  | S   | 1         |         |     |           |                  |
|            |            |             |        | 08            | 4        |         |  | S   | 1         |         |     |           |                  |
|            |            |             |        | 08            | 4        |         |  | S   | 1         |         |     |           |                  |
|            |            |             |        | 08            | 4        |         |  | S   | 1         |         |     |           |                  |
|            |            |             |        | 08            | 4        |         |  | S   | 1         |         |     |           |                  |

| ENVIRON | Wind     |             | Air_temp.  | Air_press | Secchi | Cloud cov | Sea_cond. | Sea_col | Swell_ht. | Swell_dir |
|---------|----------|-------------|------------|-----------|--------|-----------|-----------|---------|-----------|-----------|
|         | Dir.     | Force       |            |           |        |           |           |         |           |           |
|         |          |             |            |           |        |           |           |         |           |           |
|         | Bot_type | Bot_contour | Surf_temp. | Bot_temp. |        |           |           |         |           |           |
|         |          |             |            |           |        |           |           |         |           |           |

# BLUE COD POTTING SURVEY CATCH RECORD (2018 edition)

trip\_code \_\_\_\_\_

Page \_\_\_\_ of \_\_\_\_

| Vessel | Year | No |
|--------|------|----|
|        |      |    |

| Set number | strn_code |
|------------|-----------|
|            |           |

RECORDER \_\_\_\_\_

## CATCH OF BLUE COD ONLY

| Pot number | Target species | Target Sp. code | weight (kg) | Weigh method | % samp | Number | L/F | Biol. | Oto |
|------------|----------------|-----------------|-------------|--------------|--------|--------|-----|-------|-----|
|            | Blue cod       | B   C   O       | .           |              | .      |        |     |       |     |
|            | Blue cod       | B   C   O       | .           |              | .      |        |     |       |     |
|            | Blue cod       | B   C   O       | .           |              | .      |        |     |       |     |
|            | Blue cod       | B   C   O       | .           |              | .      |        |     |       |     |
|            | Blue cod       | B   C   O       | .           |              | .      |        |     |       |     |
|            | Blue cod       | B   C   O       | .           |              | .      |        |     |       |     |
|            | Blue cod       | B   C   O       | .           |              | .      |        |     |       |     |
|            | Blue cod       | B   C   O       | .           |              | .      |        |     |       |     |
|            | Blue cod       | B   C   O       | .           |              | .      |        |     |       |     |

## CATCH OF OTHER SPECIES

| Pot number | Species name | Species code | Species Weight (kg) | Weigh method | % samp | Number | L/F | Biol. | Oto |
|------------|--------------|--------------|---------------------|--------------|--------|--------|-----|-------|-----|
|            |              |              | .                   |              | .      |        |     |       |     |
|            |              |              | .                   |              | .      |        |     |       |     |
|            |              |              | .                   |              | .      |        |     |       |     |
|            |              |              | .                   |              | .      |        |     |       |     |
|            |              |              | .                   |              | .      |        |     |       |     |
|            |              |              | .                   |              | .      |        |     |       |     |
|            |              |              | .                   |              | .      |        |     |       |     |
|            |              |              | .                   |              | .      |        |     |       |     |
|            |              |              | .                   |              | .      |        |     |       |     |
|            |              |              | .                   |              | .      |        |     |       |     |
|            |              |              | .                   |              | .      |        |     |       |     |
|            |              |              | .                   |              | .      |        |     |       |     |
|            |              |              | .                   |              | .      |        |     |       |     |
|            |              |              | .                   |              | .      |        |     |       |     |
|            |              |              | .                   |              | .      |        |     |       |     |
|            |              |              | .                   |              | .      |        |     |       |     |
|            |              |              | .                   |              | .      |        |     |       |     |

Comments \_\_\_\_\_

## BLUE COD POTTING SURVEY LENGTH AND BIOLOGICAL RECORD – BLUE COD (2018 edition)

trip\_code \_\_\_\_\_

| Vessel | Year | No |
|--------|------|----|
|        |      |    |

| Set number | stn_code |
|------------|----------|
|            |          |

| MM | Species   |
|----|-----------|
| 2  | B   C   O |

Page \_\_\_ of \_\_\_

RECORDER \_\_\_\_\_

| Pot number | Fish no. | Length (cm) | Weight (g) | Sex | Gonad stage | Otolith |
|------------|----------|-------------|------------|-----|-------------|---------|
|            | 1        | .           |            |     |             |         |
|            | 2        | .           |            |     |             |         |
|            | 3        | .           |            |     |             |         |
|            | 4        | .           |            |     |             |         |
|            | 5        | .           |            |     |             |         |
|            | 6        | .           |            |     |             |         |
|            | 7        | .           |            |     |             |         |
|            | 8        | .           |            |     |             |         |
|            | 9        | .           |            |     |             |         |
|            | 0        | .           |            |     |             |         |
|            | 1        | .           |            |     |             |         |
|            | 2        | .           |            |     |             |         |
|            | 3        | .           |            |     |             |         |
|            | 4        | .           |            |     |             |         |
|            | 5        | .           |            |     |             |         |
|            | 6        | .           |            |     |             |         |
|            | 7        | .           |            |     |             |         |
|            | 8        | .           |            |     |             |         |
|            | 9        | .           |            |     |             |         |
|            | 0        | .           |            |     |             |         |
|            | 1        | .           |            |     |             |         |
|            | 2        | .           |            |     |             |         |
|            | 3        | .           |            |     |             |         |

| Pot number | Fish no. | Length (cm) | Weight (g) | Sex | Gonad stage | Otolith |
|------------|----------|-------------|------------|-----|-------------|---------|
|            | 4        | .           |            |     |             |         |
|            | 5        | .           |            |     |             |         |
|            | 6        | .           |            |     |             |         |
|            | 7        | .           |            |     |             |         |
|            | 8        | .           |            |     |             |         |
|            | 9        | .           |            |     |             |         |
|            | 0        | .           |            |     |             |         |
|            | 1        | .           |            |     |             |         |
|            | 2        | .           |            |     |             |         |
|            | 3        | .           |            |     |             |         |
|            | 4        | .           |            |     |             |         |
|            | 5        | .           |            |     |             |         |
|            | 6        | .           |            |     |             |         |
|            | 7        | .           |            |     |             |         |
|            | 8        | .           |            |     |             |         |
|            | 9        | .           |            |     |             |         |
|            | 0        | .           |            |     |             |         |

Comments \_\_\_\_\_



# BLUE COD POTTING SURVEY OTOLITH SAMPLE TICK SHEET (2018 EDITION)

trip\_code

| Vessel | Year | No. |
|--------|------|-----|
|        |      |     |

**stratum**

**Males**

| Otoliths lgth | Males |  |  |  |  |  |  |  |
|---------------|-------|--|--|--|--|--|--|--|
|               |       |  |  |  |  |  |  |  |
| 10-19         |       |  |  |  |  |  |  |  |
| 20            |       |  |  |  |  |  |  |  |
| 21            |       |  |  |  |  |  |  |  |
| 22            |       |  |  |  |  |  |  |  |
| 23            |       |  |  |  |  |  |  |  |
| 24            |       |  |  |  |  |  |  |  |
| 25            |       |  |  |  |  |  |  |  |
| 26            |       |  |  |  |  |  |  |  |
| 27            |       |  |  |  |  |  |  |  |
| 28            |       |  |  |  |  |  |  |  |
| 29            |       |  |  |  |  |  |  |  |
| 30            |       |  |  |  |  |  |  |  |
| 31            |       |  |  |  |  |  |  |  |
| 32            |       |  |  |  |  |  |  |  |
| 33            |       |  |  |  |  |  |  |  |
| 34            |       |  |  |  |  |  |  |  |
| 35            |       |  |  |  |  |  |  |  |
| 36            |       |  |  |  |  |  |  |  |
| 37            |       |  |  |  |  |  |  |  |
| 38            |       |  |  |  |  |  |  |  |
| 39            |       |  |  |  |  |  |  |  |
| 40            |       |  |  |  |  |  |  |  |
| 41            |       |  |  |  |  |  |  |  |
| 42            |       |  |  |  |  |  |  |  |
| 43            |       |  |  |  |  |  |  |  |
| 44            |       |  |  |  |  |  |  |  |
| 45            |       |  |  |  |  |  |  |  |
| 46            |       |  |  |  |  |  |  |  |
| 47            |       |  |  |  |  |  |  |  |
| 48            |       |  |  |  |  |  |  |  |
| 49            |       |  |  |  |  |  |  |  |
| 50            |       |  |  |  |  |  |  |  |
| 50+           |       |  |  |  |  |  |  |  |

## Appendix 2: Instructions for completing blue cod potting survey at-sea data forms

The standards and specifications for completing blue cod potting survey at-sea data forms are based on the NIWA trawl survey instructions. The forms are primarily designed for blue cod potting surveys but provide the option of including data collected from other methods such as line fishing or diving surveys. There are three forms that routinely need to be completed for each site where pots are set. Terms used are consistent with those defined in terminology (Section 2.)

### 1. BLUE COD POTTING SURVEY TRIP RECORD (2018)

| <b>LABEL</b> | <b>DESCRIPTION</b>   |
|--------------|--|
| Trip code    | Three characters for the vessel code, plus two digits for the year and another two digits for the trip number, e.g., chj0801. See Table A2.1 for current vessel codes. Check with Research Data Manager before assigning trip code to ensure that it is unique for the survey. |

**Table A2.1: Vessel codes used on blue cod potting surveys:**

| Vessel                       | Vessel code |
|------------------------------|-------------|
| F.V. <i>CherilynJ</i>        | chj         |
| F.V. <i>Chivalair</i>        | chv         |
| F.V. <i>Francis</i>          | fra         |
| F.V. <i>Golden Bay</i>       | gol         |
| R.V. <i>Ikatere</i>          | ika         |
| F.V. <i>Legacy</i>           | leg         |
| F.V. <i>Lady H R</i>         | lhr         |
| F.V. <i>Mystique</i>         | mys         |
| F.V. <i>Navigator</i>        | nav         |
| F.V. <i>Nimbus</i>           | nim         |
| F.V. <i>Provider</i>         | pro         |
| F.V. <i>Solitaire</i>        | slt         |
| F.V. <i>Suzanne</i>          | suz         |
| F.V. <i>Thetis</i>           | the         |
| F.V. <i>Triton</i>           | tri         |
| F.V. <i>Western Explorer</i> | wex         |

|                  |  |
|------------------|--|
| Trip start date  | Date of the first set of the survey  |
| Trip finish date | Date of the last set of the survey   |
| Recorder         | Full name of recorder (not just initials).   |
| Leader           | Names of survey voyage leaders   |
| Master           | Names of vessel skippers   |
| Project code     | Fisheries New Zealand project code, e.g., BCO201701.   |
| Area             | Survey area code that is unique within New Zealand and in the NIWA research database (rdb) (Table A2.2). |

| <b>LABEL</b>      | <b>DESCRIPTION</b>  |
|-------------------|---|
| Stratum           | All surveyed strata on this trip. Numeric or numeric/alpha for all surveys, except Dusky Sound strata where alpha labels are used (Table A2.2) (see Section 2 – Terminology). |
| Stratum area code | All surveyed stratum area codes on this trip. Four-digit alpha codes (Table A2.2)   |
| Main species      | Main target species. This will be almost exclusively blue cod (BCO).  |
| Pot Plan          | Pot Plan 1 for Marlborough Sounds survey or Pot Plan 2 for other surveys. Pot plans are shown in Figures 2–5.   |
| Pots per set      | The number of pots placed in each set. Usually nine for Marlborough Sounds and six for other surveys.   |
| Staff             | All staff that were on the vessel during the survey, including names of vessel crew.  |
| Trip comments     | Any comments on the trip. Specifically, the survey design type and pot placement used on the survey.  |

**Table A2.2: Survey area, stratum, stratum area code and description of stratum location. Both ‘stratum area codes’ and ‘description’ fields are stored in attribute *descrptn* in table *t\_stratum*.**

| Survey             | Area | Stratum                  | Stratum area codes | Description                                 |
|--------------------|------|--------------------------|--------------------|---|
| Marlborough Sounds | SNDS | 1                        | IQCS               | Inner Queen Charlotte Sound                 |
|                    |      | 2                        | OQCS               | Outer Queen Charlotte Sound                 |
|                    |      | 3                        | EOCH               | Extreme Outer Queen Charlotte Sound         |
|                    |      | 4                        | EOPE               | Extreme Outer Pelorus Sound                 |
|                    |      | 5                        | OPEL               | Outer Pelorus Sound                         |
|                    |      | 6                        | DURE               | East of D’Urville Island                    |
|                    |      | 7                        | IPEL               | Inner Pelorus                               |
|                    |      | 8                        | MPEL               | Outer Pelorus                               |
|                    |      | 9                        | DURW               | West of D’Urville Island                    |
|                    |      | 10                       | SEPR               | Separation Point (Tasman Bay)               |
|                    |      | 11                       | APAE               | Arapawa Island East                         |
|                    |      | 12                       | CKST               | Cook Strait                                 |
|                    |      | 13                       | UNDW               | Port Underwood                              |
|                    |      | 14                       | LIMR               | Long Island Marine Reserve                  |
| Kaikoura           | KAIK | 1a                       | CONW               | Conway Rocks                                |
|                    |      | 1b                       | BUSH               | Bushett Shoal                               |
|                    |      | 2                        | HAUM               | Haumuri Bluffs, to South Bay of Kaikoura    |
|                    |      | 2a                       | SOUB               | South Bay north to Hikurangi Marine Reserve |
|                    |      | 2b                       | HAUS               | Haumuri Bluffs north to Hikurangi Marine    |
|                    |      | 3                        | IKPE               | Inner Kaikoura Peninsula                    |
|                    |      | 4                        | OKPE               | Outer Kaikoura Peninsula                    |
| 5                  | HMR  | Hikurangi Marine Reserve |                    |   |
| Motunau            | MOTN | 1                        | SALT               | Salt Rock                                   |
|                    |      | 2                        | MOTI               | Motunau Island                              |
|                    |      | 3                        | DOUB               | Double Corner                               |
| Banks Peninsula    | BNKS | 1                        | LONG               | Long Bay                                    |
|                    |      | 2                        | AKAR               | Akaroa Harbour entrance                     |
|                    |      | 3                        | STON               | Stony Bay                                   |

|                |      |     |      |   |
|----------------|------|-----|------|---|
|                |      | 4   | GOUG | Goughs Bay  |
|                |      | 5   | LEBO | Le Bons Bay   |
|                |      | 6   | LEBR | Le Bons Rocks (Offshore)  |
|                |      | 7   | POMP | Pompeys Pillar Rocks (Offshore)   |
|                |      | 2AW | --   | Part of stratum 2, east of Akaroa Harbour, excluding the Akaroa Taiapure  |
|                |      | 2BW | --   | Coastline (500 m width) of Akaroa Marine Reserve (the part of stratum 2 that sits within Akaroa Marine Reserve) |
|                |      | PO  | --   | Pohatu Marine Reserve (Flea Bay)  |
|                |      |     |      |   |
| North Otago    | OTAG | 1   | MOER | Moeraki to Lookout Bluff  |
|                |      | 2   | LOOK | Lookout Bluff to Oamaru   |
|                |      | 3   | LOOO | Offshore of Lookout Bluff   |
|                |      | 4   | SHAG | Shag Point  |
|                |      | 5   | SHAO | Offshore of Shag point  |
|                |      | 6   | BOBB | Booby Head to Cornish Head (2009 onward)  |
|                |      |     |      |   |
| South Otago    | DUNE | 1   | OPEN | Otago Peninsula   |
|                |      | 2   | TAIM | Taieri Mouth  |
|                |      | 3   | OPEO | Canyons offshore of Otago Peninsula   |
|                |      | 4   | BRIO | Offshore of Brighton  |
|                |      | 5   | TAIO | Offshore of Taieri Mouth  |
|                |      | 6   | AKAO | Offshore of Akatore Creek   |
|                |      |     |      |   |
| Foveaux Strait | FOVE | 1   | SIBR | Stewart Island off Black Rock Point   |
|                |      | 2   | FSMW | Most Westerly stratum in middle of Foveaux Strait   |
|                |      | 3   | MLSH | Mainland off Steep Head   |
|                |      | 4   | SIPW | Stewart Island off Port William   |
|                |      | 5   | FSMD | Middle stratum in Foveaux Strait  |
|                |      | 6   | MLBL | Mainland off Bluff  |
|                |      | 7   | SIMI | Stewart Island - Mutton Bird Islands  |
|                |      | 8   | FSRU | Ruapuke Island in Foveaux Strait  |
|                |      | 7a  | --   | Area of rocky ground from Ruapuke Island to north-east Stewart Island   |
|                |      | 8a  | --   | Area of soft sediment surrounding Ruapuke Island to north-east Stewart Island                                   |
|                |      | 9   | MLTT | Mainland off Toes Toes Bay  |
|                |      | 10  | SIEC | East Cape of Stewart Island   |
|                |      |     |      |   |
| Paterson Inlet | PATE | 1   | WANA | North and west arms   |
|                |      | 2   | PRIN | Prices Inlet  |
|                |      | 3   | ULVA | Part 1: Between Trumpeter Point and Ulva Island; part 2: between Ulva Island and Native Island                  |
|                |      | 4   | WNHE | West of Neck and Harbour Entrance   |
|                |      | 5   | BGBA | Big Glory Bay   |
|                |      |     |      |   |
| Dusky Sound    | DUSK | INN | INNE | Inner Dusky Sound around Cooper Island  |
|                |      | MID | MIDS | Mid Dusky Sound around Long Island  |
|                |      | OUT | OUTE | Outer Dusky Sound around Pigeon island  |
|                |      | EO  | EOUT | Extreme Outer Dusky Sound around Anchor Island  |
|                |      | OC  | OPCO | Open coast at entrance to Dusky Sound   |
|                |      | MR  | MARR | Taumoana Marine reserve   |



## 2. BLUE COD POTTING SURVEY SET RECORD (2018)

| LABEL            | DESCRIPTION  |
|------------------|--|
| Trip code        | as above   |
| Area             | as above   |
| Date             | date of the set. Format = dd MMM yy, e.g., 02 MAY 10.  |
| Recorder         | as above   |
| Site type        | Circle 'F' for fixed-site set and 'R' for random-site set (see Section 2 – Terminology).   |
| Set number       | Sequential numbering of surveyed sites. If a total of 40 sites (regardless if fixed or random sites) are surveyed, the sequence would be 1 to 40 (see Section 2 – Terminology).  |
| stn_code         | A station code (stn_code) is an alphanumeric label of no more than 4 characters unique within a survey that identifies the site and will be provided to the voyage leader before the survey begins (see Section 2 – Terminology).  |
| Stratum          | Stratum number as shown in Table A2.2 (see Section 2 – Terminology).   |
| Phase            | For phase one sites enter 1, for phase two sites enter 2.<br><br>The phase is entered in the first field of attribute <b>categories</b> of table <i>t_station</i> in the <i>trawl</i> database   |
| Gear method code | <ul style="list-style-type: none"> <li>31 Bottom Long Lines (Snapper, Ling)</li> <li>32 Trolling lines</li> <li>33 Handlines</li> <li>34 Pole lines</li> <li>35 Drop/Dahn Lines (Hapuku)</li> <li>36 Trot line</li> <li>37 Rod and reel, handline</li> <li>39 Generic line</li> <li><b>51 Pots (default)</b></li> <li>52 Rock Lobster Pot</li> <li>71 Divers</li> <li><b>87 ADCP (dfault)</b></li> </ul> |
| no. of units     | Number of pots used in the set.  |
| ADCP data        | Circle 'yes' if ADCP data collected, or 'no' if ADCP data not recorded.  |

| <b>LABEL</b>  | <b>DESCRIPTION</b>   |
|---------------|--|
| Pot number    | Pots are numbered sequentially (1 to 6 or 1 to 9) in the order they are placed during a set. Pots are not uniquely identified as they are constructed from a pot plan and are all identical.   |
| <b>LABEL</b>  | <b>DESCRIPTION</b>   |
| Pot place.    | <p>Pot placement method. Enter 'D' for skipper directed pot placement around the site (fixed-site surveys) and enter 'S' for systematic pot placement around the site (random_site surveys).</p> <p>The pot placement is entered in the second field of attribute <b>categories</b> of <i>t_station</i> in the <i>trawl</i> database</p> |
| Time          |  |
| Start         | Time of day (24 hr NZST) that pot comes into contact with the bottom.  |
| Finish        | Time of day that hauling begins and pot leaves the bottom.   |
|               | format = hhmm, e.g. 0810 for 8:10 am, and 1400 for 2.00 pm.  |
| Method of fix | <p>Two character method of fixing position<br/>(complete list of codes available on the rdb database):</p> <p>01 = Radar<br/> 02 = Dead reckoning<br/> 03 = Astrofix<br/> 04 = Transect marks<br/> 05 = Radio (RDF)<br/> 06 = Radar and RDF<br/> 07 = SatNav<br/> <b>08 = GPS (default)</b><br/> 09 = Local knowledge<br/> 10 = GPX</p>  |
| Latitude      | Start and finish latitude  |
| N/S           | North or south hemisphere. S = south, N = north  |
|               | Format = degrees, minutes to 2 d.p., e.g. 45° 36.52'   |
| Longitude     | Start and finish longitude   |
| E/W           | East or west meridians. E = east, W = west   |
| Gear          |  |
| Depth         | Depth (metres) of the pot  |
| Perf.         | <p>Performance of the pot</p> <p>1 = Excellent<br/> 2 = Satisfactory, catch unlikely to be reduced by performance<br/> 3 = Unsatisfactory, catch probably reduced by malfunction or damage</p>   |
| % Bait left   | The percentage of bait (paua viscera) remaining in the snifter pottle after the pot in hauled (range 0 to 100%).   |

## Environmental data collected over the site during the set

### LABEL DESCRIPTION

#### Wind

|       |  |
|-------|--|
| Dir   | Wind direction (degrees true) 999 = no wind          |
| Force | Wind force (Beaufort scale range 0–9) (Table A2.3)   |
| Speed | Wind speed from anemometer (m/s) (1 knot = 0.51 m/s) |

**Table A2.3: Beaufort scale sea conditions. Beaufort numbers 11 to 12 not shown.**

| Beaufort number | Wind speed (m/s) | Description                        | Sea appearance  | Wave height (m) |
|-----------------|------------------|------------------------------------|---|-----------------|
| 0               | <0.3             | Calm                               | Flat  | 0               |
| 1               | 0.3–1.5          | Light air                          | Ripples without crests  | 0.1             |
| 2               | 1.5–3.5          | Light breeze                       | Small wavelets. Crests of glassy appearance, not breaking                               | 0.2             |
| 3               | 3.5–5.5          | Gentle breeze                      | Large wavelets. Crests begin to break; scattered whitecaps                              | 0.6             |
| 4               | 5.5–8            | Moderate breeze                    | Small waves   | 1               |
| 5               | 8–10.8           | Fresh breeze                       | Moderate (1.2 m) longer waves. Some foam and spray.                                     | 2               |
| 6               | 10.8–13.9        | Strong breeze                      | Large waves with foam crests and some spray.  | 3               |
| 7               | 13.9–17.2        | High wind, Moderate gale Near Gale | Sea heaps up and foam begins to streak.   | 4               |
| 8               | 17.2–20          | Fresh gale                         | Moderately high waves with breaking crests forming spindrift. Streaks of foam.          | 5.5             |
| 9               | 20.7–24.5        | Strong gale                        | High waves (6–7 m) with dense foam. Wave crests start to roll over. Considerable spray. | 7               |

Air\_temp. Air temperature (degrees Celcius to 1 d.p.)

Air\_press Air pressure (millibars to 1 d.p.)

Secchi Depth (metres to 1 d.p.) at which 30 cm Secchi disc becomes invisible

Cloud cov Cloud cover:  
 0 = Clear sky  
 1–8 = Number of eighths of sky covered

| <b>LABEL</b> | <b>DESCRIPTION</b>  |
|--------------|---|
| Sea_cond.    | Sea condition: Wave height (m)                                      |
|              | 0 = Calm, glassy 0  |
|              | 1 = Calm 0–0.1  |
|              | 2 = Smooth 0.1–0.5  |
|              | 3 = Slight 0.5–1.0  |
|              | 4 = Moderate 1.0–2.5  |
|              | 5 = Rough 2.5–4.0   |
|              | 6 = Very rough 4.0–6.0  |
|              | 7 = High 6.0–10.0   |
|              | 8 = Very high 10.0–15.0   |
|              | 9 = Huge over 15.0  |
| Sea_col      | Sea colour:   |
|              | 01 = Deep blue  |
|              | 02 = Blue   |
|              | 03 = Light blue   |
|              | 04 = Greeny blue  |
|              | 05 = Bluey green  |
|              | 06 = Deep green   |
|              | 07 = Green  |
|              | 08 = Yellow green   |
| Swell_ht.    | Height of swell:  |
|              | 1 = Low 0–2.0 m   |
|              | 2 = Moderate 2.0–4.0 m  |
|              | 3 = Heavy over 4.0 m  |
| Swell_dir    | Direction of swell (degrees true). 999 = no swell or confused swell |
| Bot_type     | Type of seafloor bottom:  |
|              | 0 = Unknown   |
|              | 1 = Mud or ooze   |
|              | 2 = Mud with some sand  |
|              | 3 = Sand  |
|              | 4 = Sand/gravel and shells  |
|              | 5 = Shells  |
|              | 6 = Gravel  |
|              | 7 = Rock  |
|              | 8 = Coral   |
|              | 9 = Stone   |
|              | 10 = sand and rocks (not in rdb)                                    |
| Bot_cont     | Bottom contour (not to be confused with general bottom typography): |
|              | 0 = Unknown   |
|              | 1 = Smooth/flat   |
|              | 2 = Undulating  |
|              | 3 = Hillocky  |
|              | 4 = Rugged  |
|              | 5 = Very rugged   |

| <b>LABEL</b> | <b>DESCRIPTION</b>                              |
|--------------|---|
| Surf_temp.   | Surface temperature (degrees Celsius to 1 d.p.) |
| Bot_temp.    | Bottom temperature (degrees Celsius to 1 d.p.)  |

### **3. BLUE COD POTTING SURVEY CATCH RECORD (2018)**

#### **Notes**

- If the catch of blue cod and bycatch species is zero for a set, then a Catch Record is not required.
- Only fill out lines for pots where catch was non-zero, i.e., if blue cod were caught in two of the pots then only two lines are required to be filled out for the blue cod section.

| <b>LABEL</b> | <b>DESCRIPTION</b> |
|--------------|--------------------|
| Trip code    | as above           |
| Set number   | as above           |
| stn_code     | as above           |
| Recorder     | as above           |

#### **CATCH OF BLUE COD ONLY**

|                 |  |
|-----------------|--|
| Pot number      | as above   |
| Target species  | Target species ( <b>Blue cod</b> by default)   |
| Target sp. code | Target species code ( <b>BCO</b> by default)   |
| weight          | Total catch weight of all blue cod (kg to 1 d.p.) from each pot.   |
| Weigh method    | The catch weight derived from one of (complete list of codes available on the rdb database). <ul style="list-style-type: none"> <li><b>1</b> = <b>Weighed (the entire catch)</b></li> <li><b>2</b> = Scaled up from subsample weight</li> <li><b>3</b> = Calculated from LF (&amp; scaled up for subsamples)</li> <li><b>4</b> = No. of cases * mean case weight</li> <li><b>5</b> = Estimated by eye</li> <li><b>6</b> = Calculated from processed weight &amp; conversion factors</li> <li><b>7</b> = Combination of weighing methods</li> <li><b>8</b> = Number of fish * mean fish weight</li> </ul> |
| % samp          | Percent (to 1 d.p.) of the blue cod catch included in the length frequency sample (this is almost always 100%, i.e., all fish were measured).  |
| Number          | The number of blue cod in each pot (must equal the number of biologicals).   |

| <b>LABEL</b> | <b>DESCRIPTION</b>   |
|--------------|--|
| L/F          | Enter 'Y' if blue cod length frequency measured from this pot, or 'N' if no blue cod length frequency measured from this pot (this is almost always Y).  |
| Biol.        | Enter 'Y' if blue cod biologicals measured from this pot, or 'N' if no blue cod biologicals measured from this pot (a biological includes one or more of individual fish weight, sexing, gonad stage, stomach contents, otoliths removed) (this is almost always Y). |
| Oto          | Enter 'Y' if blue cod otoliths were collected from this pot, or 'N' if no blue cod otoliths were collected from this pot.  |

### **CATCH OF OTHER SPECIES**

| <b>LABEL</b> | <b>DESCRIPTION</b>  |
|--------------|---|
| Pot number   | as above  |
| Species name | Common name of fish species, e.g., sea perch, tarakihi (Table A2.4). For help in identifying species consult the species field guide by McMillan et al. (2019) which should be carried aboard the vessel. |
| Species code | Species code, e.g., SPE (from NIWA research database) (Table A2.4).   |

**Table A2.4: Bycatch species commonly caught during blue cod potting.**

| Common name          | Species code | Scientific name                 |
|----------------------|--------------|---------------------------------|
| Banded Wrasse        | BPF          | <i>Notolabrus fucicola</i>      |
| Blue moki            | MOK          | <i>Latridopsis ciliaris</i>     |
| Butterfly perch      | BPE          | <i>Caesioperca lepidoptera</i>  |
| Carpet shark         | CAR          | <i>Cephaloscyllium isabella</i> |
| Common octopus       | OCT          | <i>Octopus maorum</i>           |
| Copper moki          | CMO          | <i>Latridopsis forsteri</i>     |
| Crab                 | CRB          | Decapod                         |
| Decorator crab       | NTM          | <i>Notomithrax minor</i>        |
| Girdled wrasse       | GPF          | <i>Notolabrus cinctus</i>       |
| Hagfish              | HAG          | <i>Eptatretus cirrhatus</i>     |
| Hairy conger         | HCO          | <i>Bassanago hirsutus</i>       |
| Leatherjacket        | LEA          | <i>Meuschenia scaber</i>        |
| Maori chief          | MCH          | <i>Paranotothenia augustata</i> |
| Red cod              | RCO          | <i>Pseudophycis bachus</i>      |
| Red mullet           | RMU          | <i>Upeneichthys lineatus</i>    |
| Red scorpion fish    | RSC          | <i>Scorpaena papillosa</i>      |
| Rock cod             | ROC          | <i>Lotella rhacinus</i>         |
| Rock lobster         | CRA          | <i>Jasus edwardsii</i>          |
| Scarlet wrasse       | SPF          | <i>Pseudolabrus miles</i>       |
| Sea cucumber         | SCC          | <i>Stichopus mollis</i>         |
| Sea perch            | SPE          | <i>Helicolenus percoides</i>    |
| southern bastard cod | SBR          | <i>Pseudophycis barbata</i>     |
| Southern conger      | CVR          | <i>Conger verreauxi</i>         |
| Spotty               | STY          | <i>Notolabrus celidotus</i>     |
| Starfish             | SFI          | Asteroidea & Ophiuroidea        |
| Swollen head conger  | SCO          | <i>Bassanago bulbicep</i>       |
| Tarakihi             | NMP          | <i>Nemadactylus macropterus</i> |
| Triplefin            | TRP          | Tripterygiidae                  |

| <b>LABEL</b>   | <b>DESCRIPTION</b>   |
|----------------|--|
| Species weight | Total catch weight of the species (kg to 1 d.p.) from each pot.  |
| Weigh method   | as above   |
| % sampled      | Percent (to 1 d.p.) of the fish species catch included in the length frequency sample (this is almost always 0%).  |
| Number         | The number of fish of this species in each pot.  |
| L/F            | Enter 'Y' if length frequency measured for this species from this pot, or 'N' if no length frequency measured for this species from this pot (this is almost always N).  |
| Biol.          | Enter 'Y' if biologicals measured for this species from this pot, or 'N' if no biologicals measured for this species from this pot (a biological includes one or more of individual fish weight, sexing, gonad stage, stomach contents, otoliths removed) (this is almost always N). |
| Oto            | Enter 'Y' if otoliths were collected for this species from this pot, or 'N' if no otoliths were for this species collected from this pot. (this is almost always N).   |
| Comments       | Any comments on the catch.   |

#### 4. BLUE COD POTTING SURVEY LENGTH AND BIOLOGICAL RECORD – BLUE COD (2018)

##### Note

- This form is only for blue cod length and biological data
- Please write clearly and legibly with a sharp dark pencil.

| <b>LABEL</b> | <b>DESCRIPTION</b>  |
|--------------|---|
| trip_code    | as above.   |
| Set number   | as above  |
| stn_code     | as above  |
| Recorder     | as above  |
| MM           | Measurement method code = 2 by default (Total Length, TL).  |
| Species      | BCO by default  |
| Recorder     | as above  |
| Pot number   | as above  |
| Fish no.     | This is the unique fish number for blue cod for the set. Fish numbers are sequential for all blue cod sampled from this set. If more than 30 blue cod are measured at the site, a second or more forms will be required.  |
| Length       | Blue cod length (cm) rounded down to nearest millimetre.  |
| Weight       | Weight (grams to 0 d.p.) of the individual blue cod fish (if weighed, otherwise blank)  |
| Sex          | Sex of the fish (complete list of codes are available on the rdb database):<br>1 = Male (don't use M)<br>2 = Female (don't use F)<br>3 = Unable to determine<br>4 = Did not attempt to sex fish (e.g., within marine reserve)   |
| Gonad stage  | Acceptable values 1 to 5 (Stock monitoring generic 5 stage method):<br>1, immature or resting; 2, maturing (oocytes visible in females); 3, mature (hyaline oocytes in females, milt expressible in males); 4, running ripe (eggs and milt free flowing); 5, spent. (see photographic guide in Figure 10) |
| Otolith      | Enter 'Y' = otoliths taken for this blue cod fish, or 'N' = no otoliths taken for this blue cod fish. Write these clearly as Y and N can sometimes look similar.<br><br>These are the only records of otoliths (apart from the packet) so please ensure accuracy in recording this field.                 |
| Comments     | Any comments on the length or biological sampling from this set.  |



## 5. BLUE COD POTTING SURVEY LENGTH AND BIOLOGICAL FORM FOR OTHER SPECIES (2010)

### Note

- This form is only for length and biological data of species other than blue cod.
- A new form is required for each species

| <b>LABEL</b> | <b>DESCRIPTION</b>  |   |   |                    |   |   |                      |   |   |                     |   |   |   |   |   |                      |   |   |                |   |   |              |   |   |              |   |   |  |   |   |   |   |   |                               |   |   |  |   |   |                                     |   |   |  |   |   |   |   |   |   |
|--------------|---|---|---|--------------------|---|---|----------------------|---|---|---------------------|---|---|---|---|---|----------------------|---|---|----------------|---|---|--------------|---|---|--------------|---|---|--|---|---|---|---|---|-------------------------------|---|---|--|---|---|-------------------------------------|---|---|--|---|---|---|---|---|---|
| trip code    | as above  |   |   |                    |   |   |                      |   |   |                     |   |   |   |   |   |                      |   |   |                |   |   |              |   |   |              |   |   |  |   |   |   |   |   |                               |   |   |  |   |   |                                     |   |   |  |   |   |   |   |   |   |
| Set number   | as above.   |   |   |                    |   |   |                      |   |   |                     |   |   |   |   |   |                      |   |   |                |   |   |              |   |   |              |   |   |  |   |   |   |   |   |                               |   |   |  |   |   |                                     |   |   |  |   |   |   |   |   |   |
| Recorder     | as above  |   |   |                    |   |   |                      |   |   |                     |   |   |   |   |   |                      |   |   |                |   |   |              |   |   |              |   |   |  |   |   |   |   |   |                               |   |   |  |   |   |                                     |   |   |  |   |   |   |   |   |   |
| Pot number   | as above  |   |   |                    |   |   |                      |   |   |                     |   |   |   |   |   |                      |   |   |                |   |   |              |   |   |              |   |   |  |   |   |   |   |   |                               |   |   |  |   |   |                                     |   |   |  |   |   |   |   |   |   |
| Species name | Common name of fish species, e.g., sea perch (Table A2.4)   |   |   |                    |   |   |                      |   |   |                     |   |   |   |   |   |                      |   |   |                |   |   |              |   |   |              |   |   |  |   |   |   |   |   |                               |   |   |  |   |   |                                     |   |   |  |   |   |   |   |   |   |
| Species code | Species code, e.g., SPE (from NIWA research database Table A2.4)  |   |   |                    |   |   |                      |   |   |                     |   |   |   |   |   |                      |   |   |                |   |   |              |   |   |              |   |   |  |   |   |   |   |   |                               |   |   |  |   |   |                                     |   |   |  |   |   |   |   |   |   |
| Fish no.     | This is the unique fish number for this species for the set. Fish numbers are sequential for fish of this species sampled from this set. If more than 30 fish of this species are measured at the site, a second or more forms will be required.  |   |   |                    |   |   |                      |   |   |                     |   |   |   |   |   |                      |   |   |                |   |   |              |   |   |              |   |   |  |   |   |   |   |   |                               |   |   |  |   |   |                                     |   |   |  |   |   |   |   |   |   |
| MM           | Method of length measurement used for this species, (complete list of codes available on the NIWA rdb database): <table border="0" style="margin-left: 20px;"> <tr><td>1</td><td>=</td><td>Fork length</td></tr> <tr><td>2</td><td>=</td><td>Total length</td></tr> <tr><td>3</td><td>=</td><td>Standard length</td></tr> <tr><td>4</td><td>=</td><td>Mantle length (squid)</td></tr> <tr><td>5</td><td>=</td><td>Pelvic length (rays)</td></tr> <tr><td>6</td><td>=</td><td>Carapace width</td></tr> <tr><td>7</td><td>=</td><td>Shell height</td></tr> <tr><td>8</td><td>=</td><td>Shell height</td></tr> <tr><td>B</td><td>=</td><td>Carapace length - Orbit to carapace notch (scampi)</td></tr> <tr><td>C</td><td>=</td><td>Carapace length - Base of antennal platform to posterior margin</td></tr> <tr><td>E</td><td>=</td><td>Eye to fork length (Billfish)</td></tr> <tr><td>G</td><td>=</td><td>Tip of snout to posterior end of dorsal fin (Ghost Sharks)</td></tr> <tr><td>J</td><td>=</td><td>Lower jaw to fork length (Billfish)</td></tr> <tr><td>L</td><td>=</td><td>Tail length - as legally defined for rock lobsters</td></tr> <tr><td>O</td><td>=</td><td>Orb length - length across the eye (Billfish)</td></tr> <tr><td>W</td><td>=</td><td>Tail width - as legally defined for rock lobsters</td></tr> </table> | 1   | = | Fork length        | 2 | = | Total length         | 3 | = | Standard length     | 4 | = | Mantle length (squid)                                     | 5 | = | Pelvic length (rays) | 6 | = | Carapace width | 7 | = | Shell height | 8 | = | Shell height | B | = | Carapace length - Orbit to carapace notch (scampi) | C | = | Carapace length - Base of antennal platform to posterior margin | E | = | Eye to fork length (Billfish) | G | = | Tip of snout to posterior end of dorsal fin (Ghost Sharks) | J | = | Lower jaw to fork length (Billfish) | L | = | Tail length - as legally defined for rock lobsters | O | = | Orb length - length across the eye (Billfish) | W | = | Tail width - as legally defined for rock lobsters |
| 1            | =   | Fork length   |   |                    |   |   |                      |   |   |                     |   |   |   |   |   |                      |   |   |                |   |   |              |   |   |              |   |   |  |   |   |   |   |   |                               |   |   |  |   |   |                                     |   |   |  |   |   |   |   |   |   |
| 2            | =   | Total length  |   |                    |   |   |                      |   |   |                     |   |   |   |   |   |                      |   |   |                |   |   |              |   |   |              |   |   |  |   |   |   |   |   |                               |   |   |  |   |   |                                     |   |   |  |   |   |   |   |   |   |
| 3            | =   | Standard length   |   |                    |   |   |                      |   |   |                     |   |   |   |   |   |                      |   |   |                |   |   |              |   |   |              |   |   |  |   |   |   |   |   |                               |   |   |  |   |   |                                     |   |   |  |   |   |   |   |   |   |
| 4            | =   | Mantle length (squid)   |   |                    |   |   |                      |   |   |                     |   |   |   |   |   |                      |   |   |                |   |   |              |   |   |              |   |   |  |   |   |   |   |   |                               |   |   |  |   |   |                                     |   |   |  |   |   |   |   |   |   |
| 5            | =   | Pelvic length (rays)  |   |                    |   |   |                      |   |   |                     |   |   |   |   |   |                      |   |   |                |   |   |              |   |   |              |   |   |  |   |   |   |   |   |                               |   |   |  |   |   |                                     |   |   |  |   |   |   |   |   |   |
| 6            | =   | Carapace width  |   |                    |   |   |                      |   |   |                     |   |   |   |   |   |                      |   |   |                |   |   |              |   |   |              |   |   |  |   |   |   |   |   |                               |   |   |  |   |   |                                     |   |   |  |   |   |   |   |   |   |
| 7            | =   | Shell height  |   |                    |   |   |                      |   |   |                     |   |   |   |   |   |                      |   |   |                |   |   |              |   |   |              |   |   |  |   |   |   |   |   |                               |   |   |  |   |   |                                     |   |   |  |   |   |   |   |   |   |
| 8            | =   | Shell height  |   |                    |   |   |                      |   |   |                     |   |   |   |   |   |                      |   |   |                |   |   |              |   |   |              |   |   |  |   |   |   |   |   |                               |   |   |  |   |   |                                     |   |   |  |   |   |   |   |   |   |
| B            | =   | Carapace length - Orbit to carapace notch (scampi)              |   |                    |   |   |                      |   |   |                     |   |   |   |   |   |                      |   |   |                |   |   |              |   |   |              |   |   |  |   |   |   |   |   |                               |   |   |  |   |   |                                     |   |   |  |   |   |   |   |   |   |
| C            | =   | Carapace length - Base of antennal platform to posterior margin |   |                    |   |   |                      |   |   |                     |   |   |   |   |   |                      |   |   |                |   |   |              |   |   |              |   |   |  |   |   |   |   |   |                               |   |   |  |   |   |                                     |   |   |  |   |   |   |   |   |   |
| E            | =   | Eye to fork length (Billfish)                                   |   |                    |   |   |                      |   |   |                     |   |   |   |   |   |                      |   |   |                |   |   |              |   |   |              |   |   |  |   |   |   |   |   |                               |   |   |  |   |   |                                     |   |   |  |   |   |   |   |   |   |
| G            | =   | Tip of snout to posterior end of dorsal fin (Ghost Sharks)      |   |                    |   |   |                      |   |   |                     |   |   |   |   |   |                      |   |   |                |   |   |              |   |   |              |   |   |  |   |   |   |   |   |                               |   |   |  |   |   |                                     |   |   |  |   |   |   |   |   |   |
| J            | =   | Lower jaw to fork length (Billfish)                             |   |                    |   |   |                      |   |   |                     |   |   |   |   |   |                      |   |   |                |   |   |              |   |   |              |   |   |  |   |   |   |   |   |                               |   |   |  |   |   |                                     |   |   |  |   |   |   |   |   |   |
| L            | =   | Tail length - as legally defined for rock lobsters              |   |                    |   |   |                      |   |   |                     |   |   |   |   |   |                      |   |   |                |   |   |              |   |   |              |   |   |  |   |   |   |   |   |                               |   |   |  |   |   |                                     |   |   |  |   |   |   |   |   |   |
| O            | =   | Orb length - length across the eye (Billfish)                   |   |                    |   |   |                      |   |   |                     |   |   |   |   |   |                      |   |   |                |   |   |              |   |   |              |   |   |  |   |   |   |   |   |                               |   |   |  |   |   |                                     |   |   |  |   |   |   |   |   |   |
| W            | =   | Tail width - as legally defined for rock lobsters               |   |                    |   |   |                      |   |   |                     |   |   |   |   |   |                      |   |   |                |   |   |              |   |   |              |   |   |  |   |   |   |   |   |                               |   |   |  |   |   |                                     |   |   |  |   |   |   |   |   |   |
| Length       | Length (cm) rounded down to nearest cm class, e.g., 31.4 = 31, 31.9 = 31  |   |   |                    |   |   |                      |   |   |                     |   |   |   |   |   |                      |   |   |                |   |   |              |   |   |              |   |   |  |   |   |   |   |   |                               |   |   |  |   |   |                                     |   |   |  |   |   |   |   |   |   |
| Weight       | Weight (g) of the individual fish (if recorded)   |   |   |                    |   |   |                      |   |   |                     |   |   |   |   |   |                      |   |   |                |   |   |              |   |   |              |   |   |  |   |   |   |   |   |                               |   |   |  |   |   |                                     |   |   |  |   |   |   |   |   |   |
| Sex          | Sex of the fish (complete list of codes available on the rdb database): <table border="0" style="margin-left: 20px;"> <tr><td>1</td><td>=</td><td>Male (don't use M)</td></tr> <tr><td>2</td><td>=</td><td>Female (don't use F)</td></tr> <tr><td>3</td><td>=</td><td>Unable to determine</td></tr> <tr><td>4</td><td>=</td><td>Did not attempt to sex fish (e.g., within marine reserve)</td></tr> </table>  | 1   | = | Male (don't use M) | 2 | = | Female (don't use F) | 3 | = | Unable to determine | 4 | = | Did not attempt to sex fish (e.g., within marine reserve) |   |   |                      |   |   |                |   |   |              |   |   |              |   |   |  |   |   |   |   |   |                               |   |   |  |   |   |                                     |   |   |  |   |   |   |   |   |   |
| 1            | =   | Male (don't use M)  |   |                    |   |   |                      |   |   |                     |   |   |   |   |   |                      |   |   |                |   |   |              |   |   |              |   |   |  |   |   |   |   |   |                               |   |   |  |   |   |                                     |   |   |  |   |   |   |   |   |   |
| 2            | =   | Female (don't use F)  |   |                    |   |   |                      |   |   |                     |   |   |   |   |   |                      |   |   |                |   |   |              |   |   |              |   |   |  |   |   |   |   |   |                               |   |   |  |   |   |                                     |   |   |  |   |   |   |   |   |   |
| 3            | =   | Unable to determine   |   |                    |   |   |                      |   |   |                     |   |   |   |   |   |                      |   |   |                |   |   |              |   |   |              |   |   |  |   |   |   |   |   |                               |   |   |  |   |   |                                     |   |   |  |   |   |   |   |   |   |
| 4            | =   | Did not attempt to sex fish (e.g., within marine reserve)       |   |                    |   |   |                      |   |   |                     |   |   |   |   |   |                      |   |   |                |   |   |              |   |   |              |   |   |  |   |   |   |   |   |                               |   |   |  |   |   |                                     |   |   |  |   |   |   |   |   |   |

| <b>LABEL</b> | <b>DESCRIPTION</b>   |
|--------------|--|
| Gonad stage  | Consult the NIWA rdb database and Research Data Manager before the survey to ascertain the correct gonad staging classification for the species of interest. |
| Otolith      | Enter 'Y' = otoliths taken for this fish, or 'N' = no otoliths taken for this fish. Write these clearly as Y and N can sometimes look similar.               |
| Comments     | Any comments on the length or biological sampling from this set.   |